

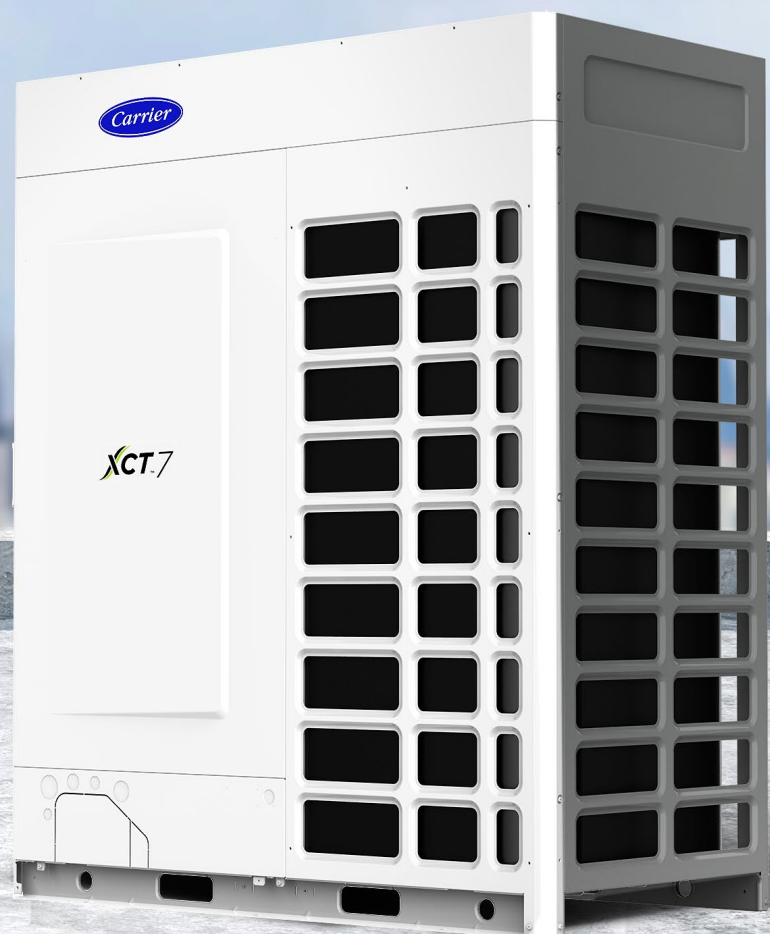

Turn to the experts

# XCT.7 VRF System



2021-2022





Turn to the experts





<b>OUR LEGACY</b> .....	003
<b>VRF SYSTEMS</b> .....	009
<b>PRODUCT LINEUP</b> .....	017
OUTDOOR UNITS LINEUP .....	017
INDOOR UNITS LINEUP .....	019
CONTROLLER UNITS LINEUP .....	021
<b>OUTDOOR UNITS</b> .....	024
SIDE DISCHARGE HEAT PUMP .....	026
TOP DISCHARGE HEAT PUMP .....	044
TOP DISCHARGE HEAT RECOVERY .....	053
<b>INDOOR UNITS</b> .....	062
ONE-WAY CASSETTE .....	067
TWO-WAY CASSETTE .....	071
COMPACT FOUR-WAY CASSETTE .....	075
ROUND-WAY CASSETTE .....	079
SLIM DUCT (0/30PA) .....	085
STANDARD STATIC DUCT (20/200PA) .....	089
HIGH STATIC DUCT(0/200PA) .....	093
HIGH WALL .....	099
TWO-WAY CONSOLE .....	103
CONSOLE-RECESSED .....	107
FLEX CEILING FLOOR (AC MOTOR) .....	109

FLEX CEILING FLOOR (DC MOTOR) .....	111
HRV .....	117
<b>AHU DX KITS CONNECTION</b> .....	122
TA CONTROL TYPE .....	123
DDC CONTROL TYPE.....	125
UNIT STRUCTURE.....	127
<b>CONTROLLER</b> .....	130
INDIVIDUAL CONTROLLER .....	135
CENTRALIZED CONTROLLER .....	137
BMS .....	141
<b>ACCESSORIES</b> .....	153
HEAT PUMP - ODU PIPING CONNECTION ACCESSORIES.....	154
HEAT PUMP - IDU PIPING CONNECTION ACCESSORIES.....	155
HEAT RECOVERY - ODU PIPING CONNECTION ACCESSORIES.....	157
HEAT RECOVERY - IDU PIPING CONNECTION ACCESSORIES.....	161
HEAT RECOVERY - VALVE BOX .....	163





Turn to the experts

# Carrier's Heritage: The Invention that Changed the World

On July 17, 1902, Willis Carrier designed the first modern air-conditioning system to solve a production problem at the Sackett & Wilhelms printing plant in Brooklyn, New York, launching an industry that would fundamentally improve the way we live, work and play.

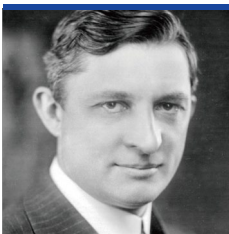

Willis Carrier applied for a patent on his invention, an "Apparatus for Treating Air." He had invented the world's first spray-type air conditioning equipment, able to both wash and humidify or dehumidify air. Modern air conditioning now had its fundamental building block.



Carrier hires America's first woman air-conditioning engineer, right around the time that the decision to allow U.S. women the right to vote was being debated by lawmakers.

1904

1917

1911

1922

Willis Carrier's Rational Psychrometric Formulae brought science to what had been the often hit-or-miss design of air-conditioning systems, and in the process made Carrier an international name.

Carrier unveiled the first centrifugal chiller, which opened the door to large-scale comfort air-conditioning.







Carrier introduces the first home air conditioner.

1926

Willis Carrier is named one of Time magazine's "100 Most Influential People of the Century."

1998

1931

The M.V. Victoria became the first vessel to make its maiden voyage equipped with Carrier air conditioning.



2016

Construction began on the Center for Intelligent Buildings Carrier Global Corporation Headquarters.





Turn to the experts

35

Carrier is a world leader in heating, air-conditioning and refrigeration solutions. We constantly build upon our history of proven innovation with new products and services that improve global comfort and efficiency.

10

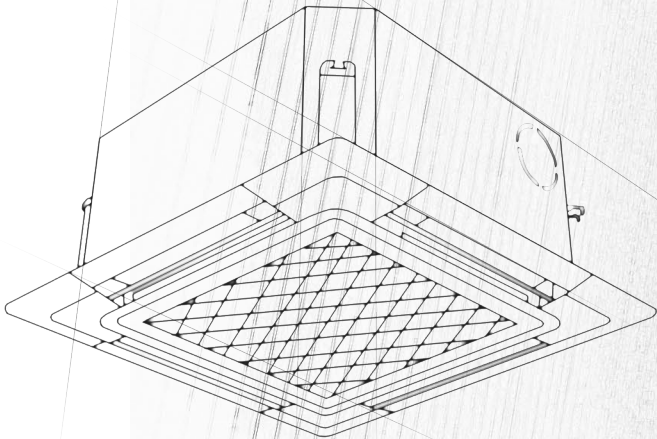

20



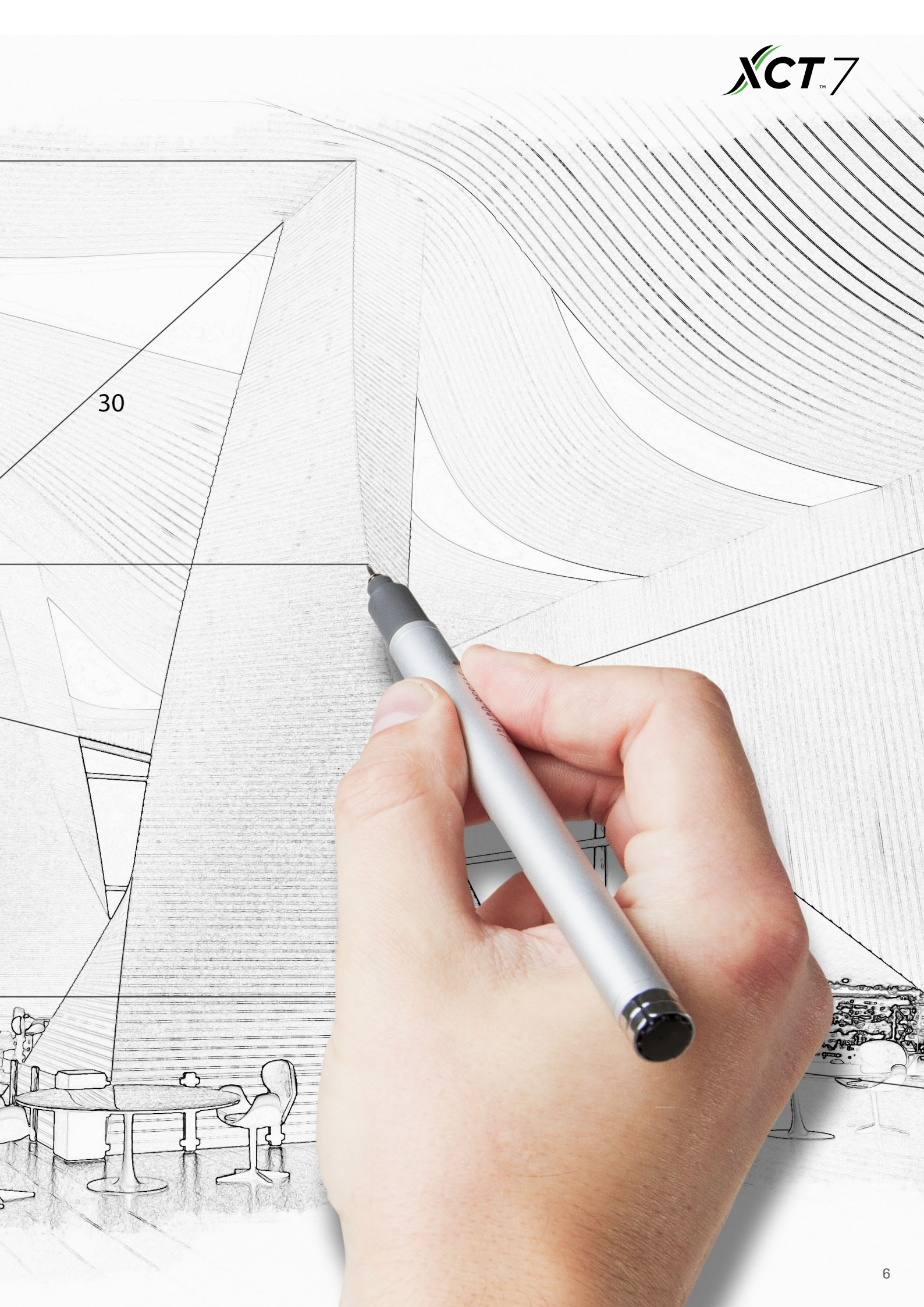

30





Turn to the experts

# Innovation

## A Leading Legacy

Carrier was built on a legacy of innovation – beginning with our founders. We are innovators at heart and inventors by heritage. From the start, we've led in pioneering new technologies and in enabling entirely new industries that have changed the world. Today, building on our history of firsts, we're boldly advancing the industries we created to make a difference in people's lives.

## Innovating Everywhere

Our industry-leading solutions and services are keeping buildings and homes across the globe comfortable, safe and secure.

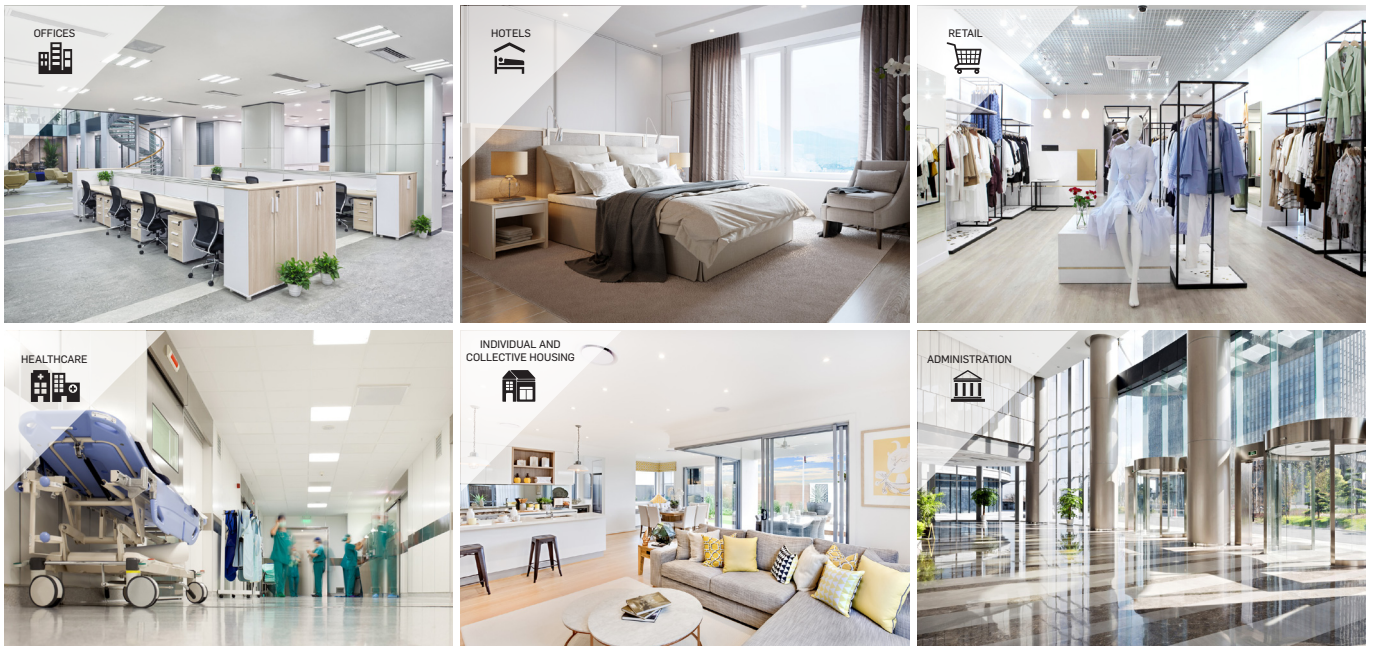



# Carrier, meeting the challenge of regulatory changes

Carrier is committed to limiting the environmental impact of its products and solutions and reducing energy consumption.

The energy efficiency improvement target strongly influences the HVAC market. Indeed, buildings are the largest consumers of energy today and, of that consumption, HVAC systems account for considerably more than other equipment. Providing its customers with energy efficient solutions is therefore now a key sustainable development opportunity for the HVAC industry.

## New metrics because seasonal efficiency matters

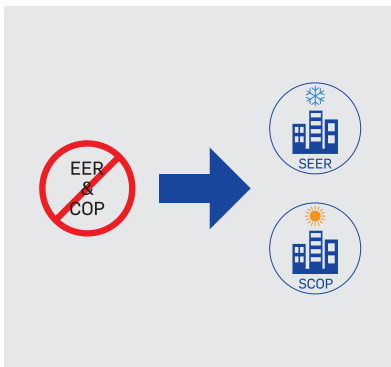

EER & COP belong to the past. In order to compare the energy efficiency of products using different sources of energy, the Ecodesign regulation introduces a measurement expressed in primary energy:  $\eta_{s,cool}$  is the equivalent of SEER for comfort cooling applications and  $\eta_{s,heat}$  is the equivalent of SCOP for space heating.

This is a more accurate indicator as it considers performance in cold seasons with temperature variations on many measurement points. This will contribute to maximize the energy consumption of the whole VRF system.

Seasonal efficiency coefficient calculation:

$$\eta_{S,H} = \frac{\text{Annual heating demand}}{\text{Annual energy consumption}}$$

$$\eta_{S,H} = \frac{\text{Annual cooling demand}}{\text{Annual energy consumption}}$$

SEER :  $2.5 \cdot \eta_{S,C}$  ; SCOP :  $2.5 \cdot \eta_{S,H}$

Carrier display SEER, SCOP,  $\eta_{sh}$ ,  $\eta_{sc}$  throughout all catalogue in order to facilitate product selection.

## Carrier subscribes to Eurovent Certita Certification program

With this certification program, all manufacturers can easily benchmark competitors' products by using the common database provided by Eurovent.

Design offices and customers do not have to organize manufacturing testing and performances check when they select certified products as all data have been compiled.



This certification guarantees the accuracy of products' data.

For detailed information, please refer to : [www.eurovent-certita.com](http://www.eurovent-certita.com)



Turn to the experts

# Understanding VRF Systems

## SETTING THE STANDARD FOR FLEXIBILITY, EFFICIENCY & PERFORMANCE

Variable Refrigerant Flow (VRF) systems are large-scale ductless HVAC systems performing at high capacity. VRF technology has the unmatched ability for multiple indoor units or zones to operate on the same outdoor system.

It is a multi-outdoor-units solution that carefully computes the precise amount of refrigerant required by each indoor unit to achieve individualized temperature control for each comfort zone.

Thanks to its flexibility, VRF systems can be customized to meet the specific demands of any project. It controls the refrigerant flow according to the heat load requirement to avoid over cooling or heating effectively.

## Why Choose VRF Systems?



### FLEXIBILITY

Whether you're looking to maximize comfort in a new building or retrofit an existing one, VRF systems join design flexibility with potential energy savings.



### EFFICIENCY

VRF systems use minimal ductwork, and sometimes none at all (depending on the application). This makes installation and maintenance easier, and also precisely matches power requirements to eliminate any energy waste associated with central duct systems.



### PERFORMANCE

System performance is significantly enhanced because of the heat transfer properties of refrigerant over other mediums, while the zone temperature control brings ideal comfort.



## **A TOTAL SYSTEM SOLUTION**

Unlike other HVAC solutions, VRF is a closed-loop system - not just components. This means you get a complete solution from the start with the confidence that everything will work seamlessly together.





Turn to the experts





## What is Carrier XCT7?

The new XCT7, Variable (X) Comfort Technology, is the 7th generation of our VRF system that proudly represents Carrier's world leading innovation, technology and unyielding commitment to energy saving.

Carrying forth the legacy that shaped the climate control industry, Carrier's VRF systems have always delivered optimal comfort and performance that can be scaled to meet climate control needs, all the way from a small single-family residence to a commercial high-rise building. We're determined to make global impacts again with the XCT7 – a VRF system that provides unmatched advantages of high reliability, peak performance, enhanced efficiency, longer lifespan, optimal user experience and easy operation.



Ultimate Reliability



Enhanced System Performance



High-Efficiency



Large Operating Range



Easy Installation



Incredible Flexibility



Wide Range of Options





Turn to the experts

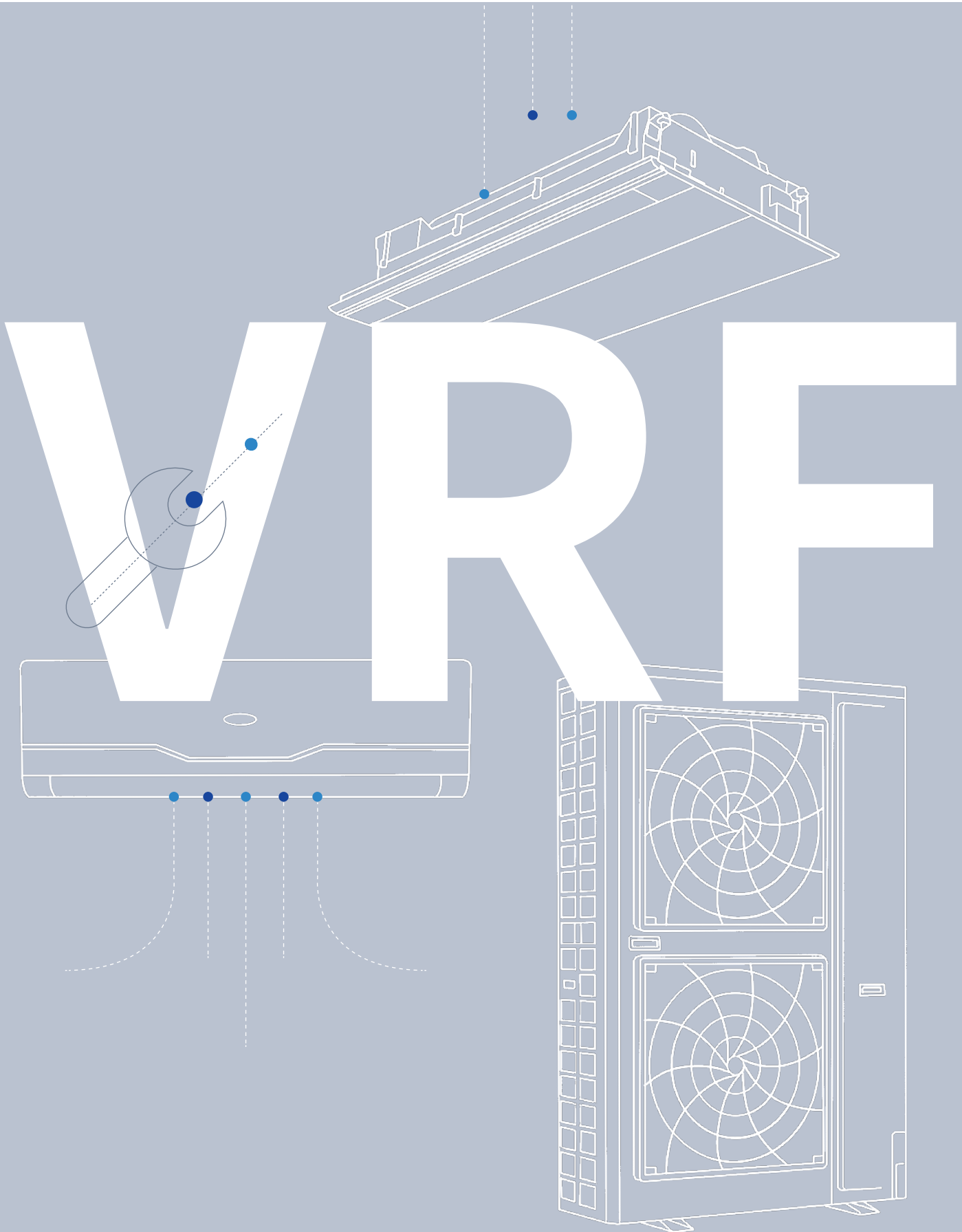

# Why Choose Carrier VRF?

Your choice of VRF system makes a difference. When you invest in Carrier VRF, you create a system that delivers on the promise of comfort, performance and reliability - the backbone of Carrier confidence.



## Ultimate Reliability

**Reliability is at the heart of XCT7 conception which brings customers a total peace of mind.**

- Outdoor condenser with advanced black-coated fin technology for enhanced corrosion resistance
- Reduced liquid shock failure rate thanks to the anti-liquid shock technology of the compressor



## Enhanced System Performance

**The enhanced system efficiency relies on the combination of the following advanced features:**

- Improved refrigerant distribution balance thanks to the centrifugal oil separator
- Smooth supply of lubricant with 10-stage oil return technology which protects the compressor and the system



## High-Efficiency

**Carrier VRF achieves high-efficiency in cooling and heating by utilizing:**

- High-efficient DC fan
- Advanced DC compressor



## Large Operating Range

**XCT7 units deliver comfort solutions for any indoor space, anytime of the year.**

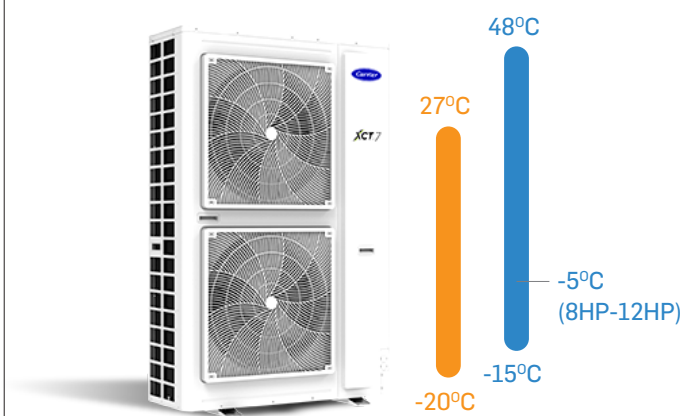
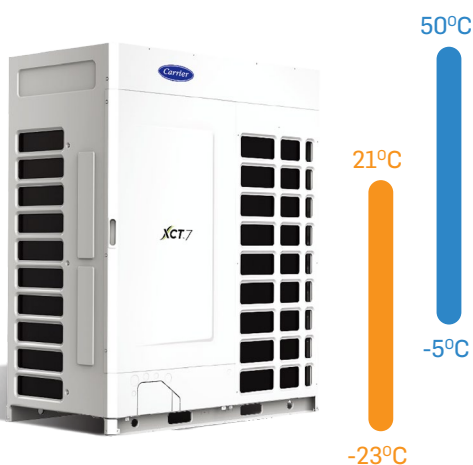





Turn to the experts

## Why Choose Carrier VRF?



### Easy Installation

**By design, Carrier VRF systems are user-friendly, providing easy installation and maintenance.**

- Easy to open the front panel
- Easy access to the internal system components
- Branching kit designed to fit your requirements
- One button trial operation :
  - Saves 10% of test operation time
  - Tests all units in one go



### Incredible Flexibility

**XCT7 units provide flexibility to accommodate almost any building requirement.**

- Compact solution, perfect for limited space applications
- Up to 110 Pa of the external static pressure available
- Easily serves high-rise buildings up to 110m
- Flexible piping layout



### Wide Range of Options

**XCT7 units have been designed to satisfy your needs. No matter the building, application or project specifications, Carrier has a VRF solution for you.**

- Single module from 4 to 26 HP
- 4 modules combination, up to 104 HP
- IDU solutions for every scenario
- Up to 64 indoor units per outdoor system
- User friendly controller solutions

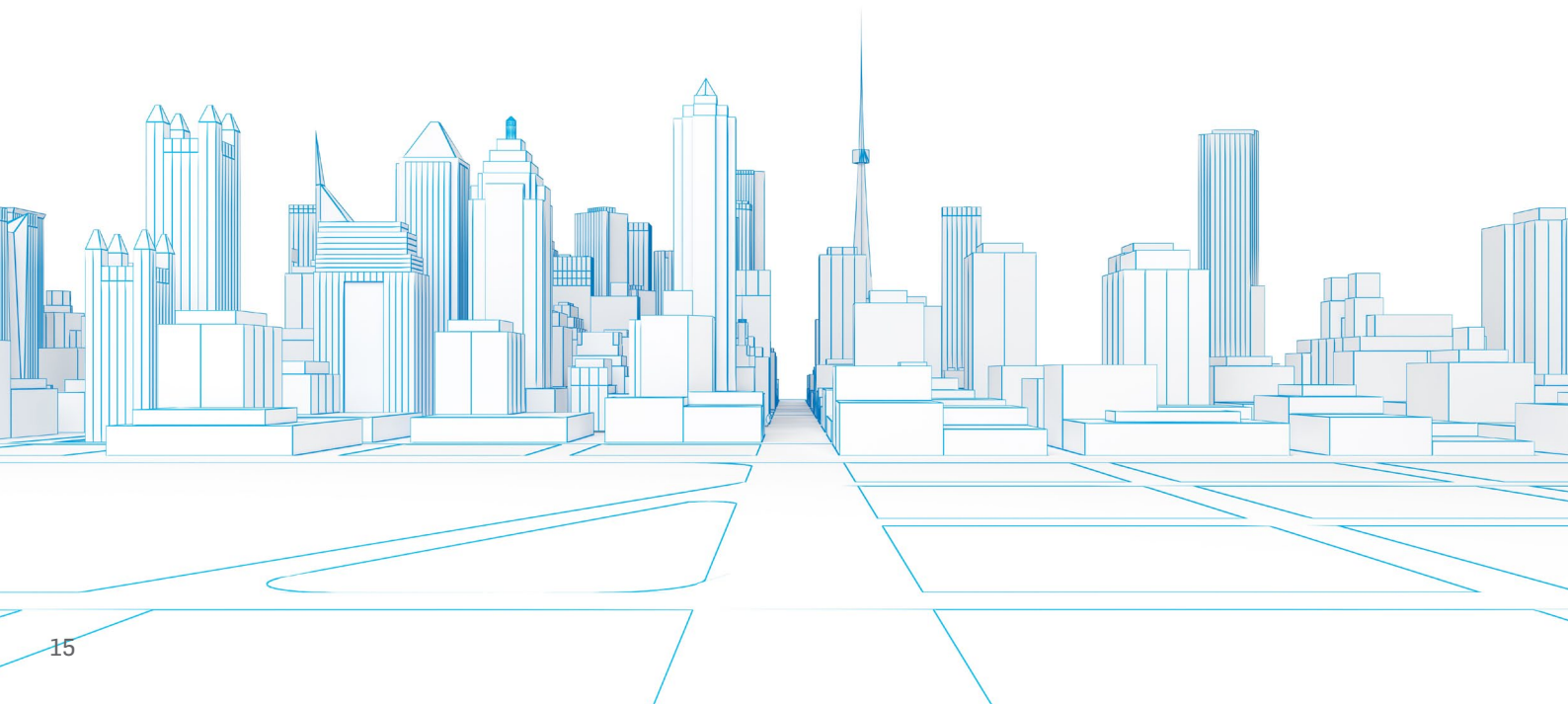

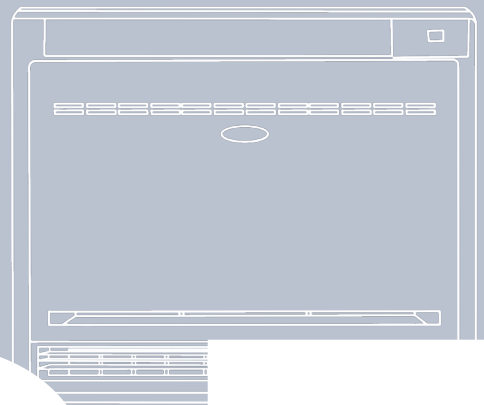
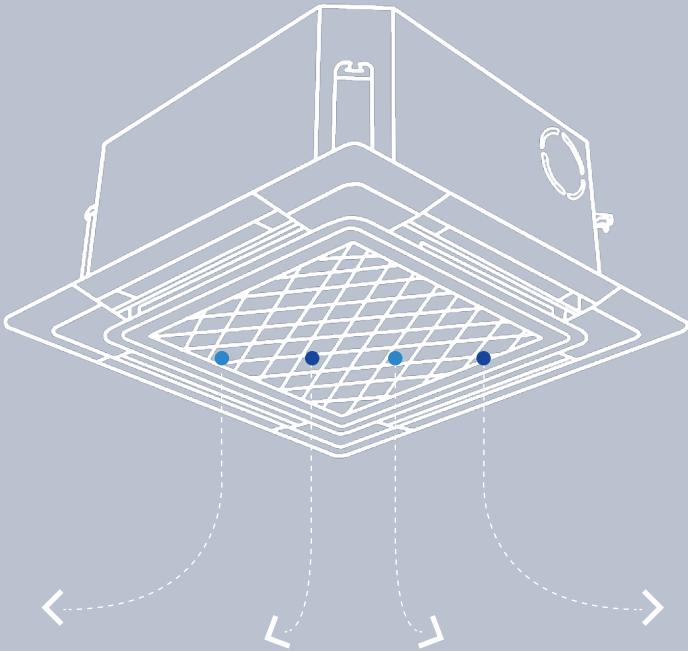

# VRF

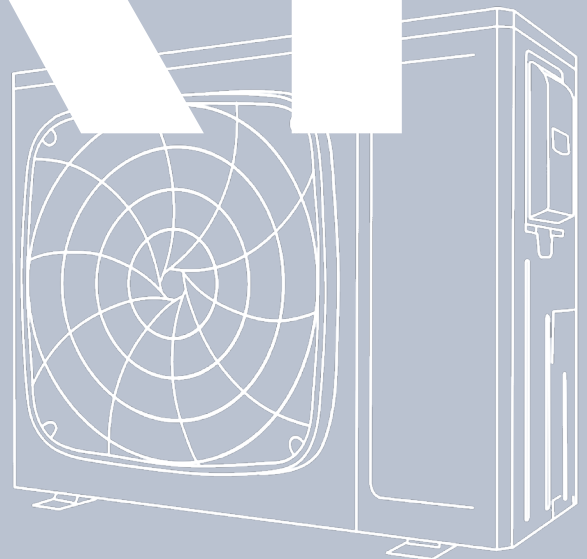



# Outdoor Units Lineup

Lineup (HP)	4										5			6																								
kW	12,1										14,0			15,5																								
Side Discharge Heat Pump	1 Ph					1&3 Ph					1 Ph			1&3 Ph			1&3 Ph																					
Lineup (HP)	8	10	12	14	16	18	20	22	24	26	28	30	32	34	36	38	40	42	44	46	48	50	52															
kW	25,2	28	33,5	40	45	50,4	56	61,5	68	73,5	80	85	90	95,4	100,8	106,4	112	117,5	123	129,5	136	141,5	147															
Top Discharge Heat Pump up to 104HP																																						
Lineup (HP)	8	10	12	14	16	18	20	22	24	26	28	30	32	34	36	38	40	42	44																			
kW	22,4	28	33,5	40	45	50	56	60	67	73,5	80	85	90	95	100	106	112	116	120																			
Top Discharge Heat Recovery up to 88HP																																						

8						10										12										
22,6						28,0										31,5										
3 Ph						3 Ph										3 Ph										
54	56	58	60	62	64	66	68	70	72	74	76	78	80	82	84	86	88	90	92	94	96	98	100	102	104	
151,2	156,8	162,4	168	173,5	179	184,5	191	197,5	204	209,5	215	220,5	224	229,5	235	240,5	246	252,5	259	265,5	272	277,5	283	288,5	294	
46						48	50	52	54	56	58	60	62	64	66	68	70	72	74	76	78	80	82	84	86	88
130						135	140	145	150	156	162	168	172	176	180	190	195	200	206	212	218	224	228	232	236	240





Turn to the experts









# Indoor Units Lineup

Capacity kW/kBTU/h	ONE-WAY CASSETTE  40VU*1-7E	TWO-WAY CASSETTE  40VU*2-7G	COMPACT FOUR-WAY CASSETTE  40VU*C-7S	ROUND-WAY CASSETTE  40VU*R-7E	SLIM DUCT  40VD*L-7E	STANDARD STATIC DUCT 20/200 Pa  40VD*S-7S
Fan Motor Type	DC	AC	DC	DC	DC	DC
1.5/5	●		●		●	●
2.2/7	●	●	●	●	●	●
2.8/9	●	●	●	●	●	●
3.6/12	●	●	●	●	●	●
4.5/16		●	●	●	●	●
5.6/18		●	●	●	●	●
7.1/24				●	●	●
8.0/28				●		●
9.0/30				●		●
11.2/38				●		●
14.0/48				●		●
16.0/54				●		●

Capacity kW/kBTU/h	HIGH STATIC DUCT 0/200 Pa  40VD*H-7S	HIGH WALL  40VK*S-7S	TWO-WAY CONSOLE  40VL*B-7E	CONSOLE - RECESSED  40VL*R-7G	FLEX CEILING FLOOR  40VC*F-7G	FLEX CEILING FLOOR  40VC*F-7S
Fan Motor Type	DC	DC	DC	AC	AC	DC
1.5/5		●	●			
2.2/7	●	●	●	●		
2.8/9	●	●	●	●	●	●
3.6/12	●	●	●	●	●	●
4.5/16	●	●			●	●
5.6/18	●	●	●		●	●
7.1/24	●	●			●	●
8.0/28	●	●				●
9.0/30	●	●				●
11.2/38	●					●
14.0/48	●					●
16.0/54	●					●



# Controller Units Lineup

<b>INDIVIDUAL CONTROLLER</b>	Remote Controller	 Wireless Controller	 Receiver (Duct unit)			
	Wired Controller	 Simple Wired Controller	 Wired Controller	 Wired Weekly Timer		
<b>CENTRALIZED CONTROLLER</b>		 Group Controller up to 32 IDU	 Touchscreen up to 256 IDU	 Touchscreen up to 800 IDU		
<b>ADAPTER</b>		 Protocol Adapter Modbus to RS485	 Protocol Adapter & Electricity Data Collection	 Protocol Adapter for Touchscreen		
<b>BMS</b>		 Remote monitoring BACnet® / Modbus IP	 Local PC control RS485 to USB	 Lonworks™ Gateway	 KXN® Gateway	 BACnet® Gateway







Turn to the experts



OFFICES



RETAIL



ADMINISTRATIONS



## OUTDOOR UNITS

- 025      SIDE DISCHARGE HEAT PUMP
- 043      TOP DISCHARGE HEAT PUMP
- 053      TOP DISCHARGE HEAT RECOVERY





Turn to the experts



Outdoor





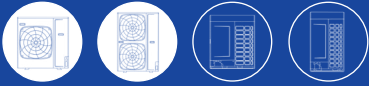

# SIDE DISCHARGE

Compact design for flexible application in small or narrow spaces





## Carrier Product Benefits

4/5 HP



### Easy Installation

- 1 Double side '4' handles**  
Easy to carry
- 2 '888' test panel**  
All running data and error codes can be checked from '888' screen, which is easy for installers
- 3 Four-way pipe connection**  
Four-way (front, back, left and right) pipe connection, easy to design and install



### Compact design

- Lower to 90kg net weight
- Compact design with only 0.35m<sup>2</sup> footprint
- Limited refrigerant charge with 3.3 kg

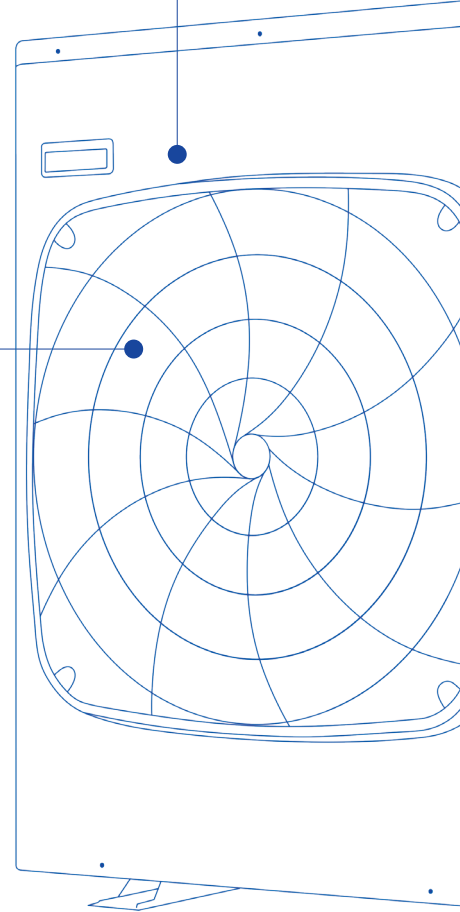

Outdoor

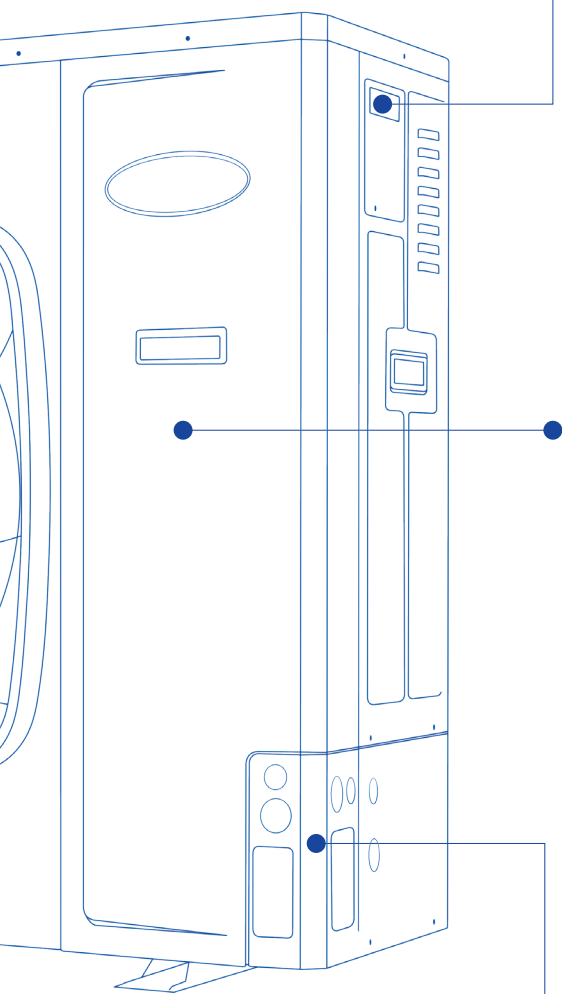

## DC Fan and Motor

### DC power brings higher efficiency to running partial load

- 16-stage speed control; high-efficiency running especially in low speed
- 45% higher efficiency than AC motors
- Lower power input

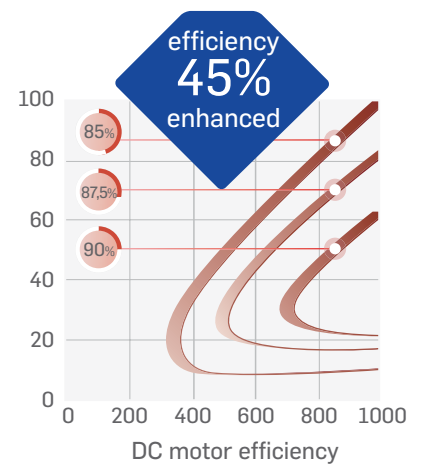
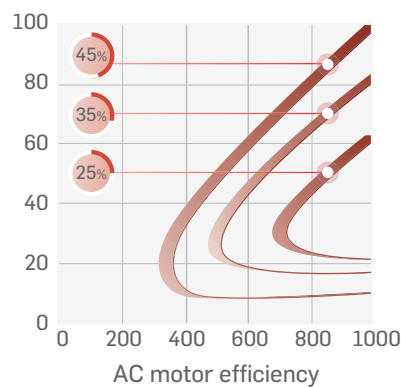

- **Large diameter fan**

The large fan of 550 mm diameter allows for greater airflow and hence, higher efficiency



DC motor



Ø550mm fan

- **New DC inverter with twin rotary compressor**

Small torque changes & good dynamic balance allows the system to run stably, with little vibration, low noise and higher efficiency when running partial load

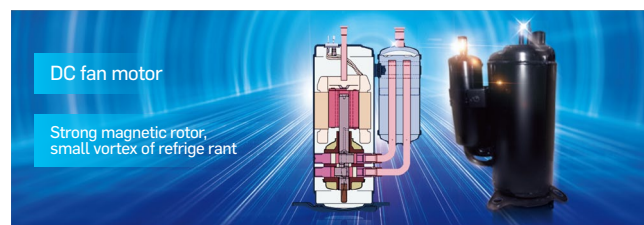

DC fan motor

Strong magnetic rotor, small vortex of refrigerant



## Superior Comfort

### New aerodynamic fan

550mm super big diameter aerospace helix fan lowers sound level by 3dB(A)

Outdoor





## Carrier Product Benefits 4/5/6 HP



### Leadership in Advanced Technology

- **Two-stage Sub-cooling Cycle Technology**  
Increases unit efficiency by 9%.
- **Maximizing 30°C Sub-cooling**  
Increase unit cooling capacity by 46%
- **Adding of the Sub-cooler at the Bottom of the Outdoor Exchanger**  
Increases the efficiency of the sub-cooling in the system to achieve deep sub-cooling

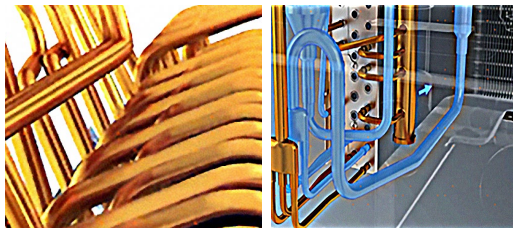

Outdoor

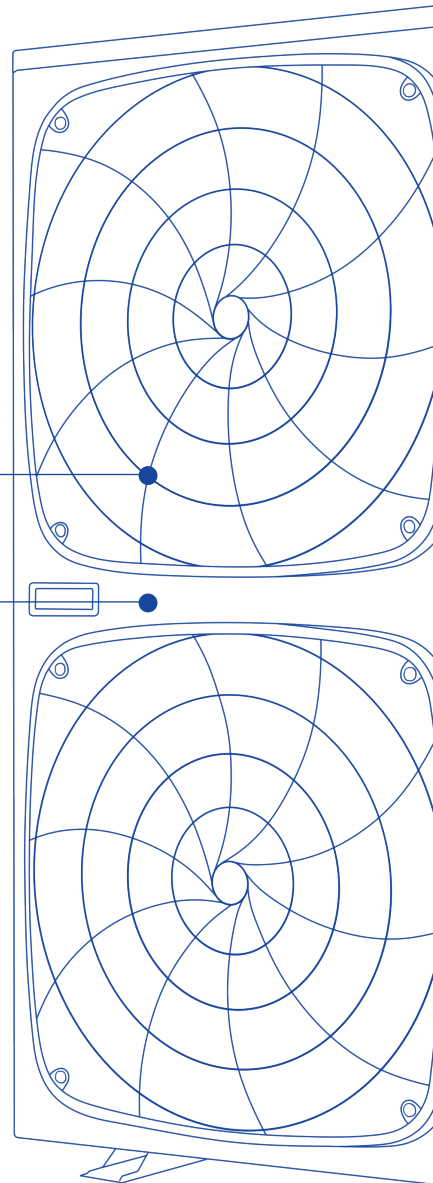

### More Powerful Heating Capacity by Enthalpy Injection

In low ambient conditions, condenser heat rejection is weakened. The amount of hot gas returning to the compressor is greatly reduced. However, the Indoor units can receive more heating capacity thanks to residual enthalpy injection from the 2nd stage subcooling.

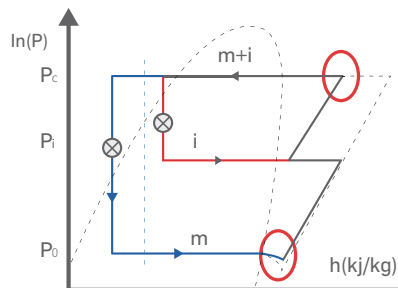
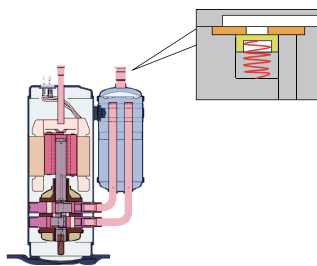

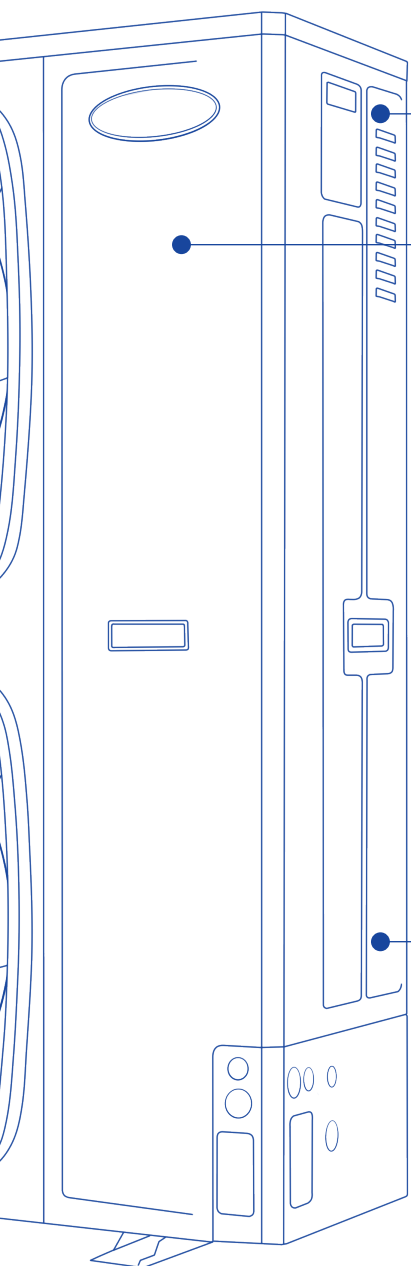

### High-Efficacy

- **DC Inverter Compressor**  
Carrier XCT7 unit uses DC inverter compressors, with 5% lower power input (14 kW)
- **Large 550 mm DC powered fan**  
38% lower power input, 8% higher airflow
- **Larger heat exchanger**  
Heat exchange area increased by 10%
- **Charge valve**  
Built-in charge valve enables safer and easier maintenance
- **Low standby power**  
New PCB program reduces 20% standby power consumption



### DC Fan and Motor

#### DC power brings higher efficiency to running partial load

- 16-stage speed control; high-efficiency running especially in low speed
- 45% higher efficiency than AC motors
- Lower power input

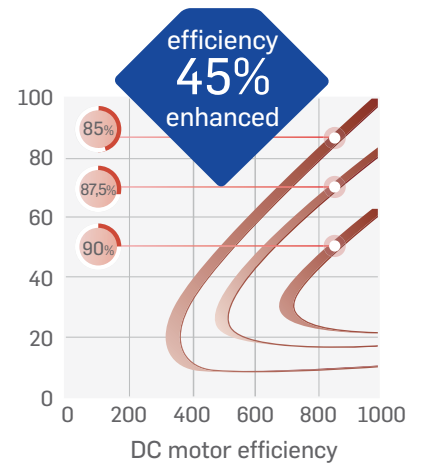
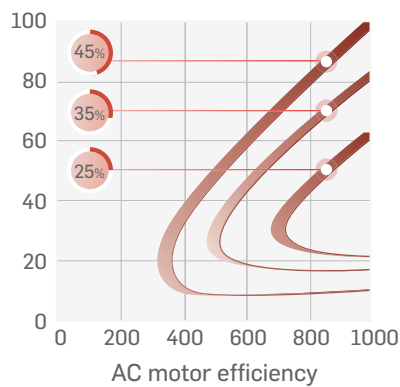

### Large diameter fan

The large fan of 550 mm diameter allows for greater airflow and hence, higher efficiency



DC motor



Ø550mm fan



### Superior Comfort

#### New aerodynamics fan

550mm super big diameter aerospace helix fan lowers sound level by 3dB(A)

Outdoor



## Carrier Product Benefits

4/5/6 HP

8/10/12 HP



### High Efficiency

- **DC Inverter Compressor**  
Carrier XCT7 uses DC INV. compressors, with 5% lower power input (14 kW)
- **Larger heat exchanger**  
Heat exchange area increased by 10%
- **Charge valve**  
Built-in charge valve to enable safer and easier maintenance
- **Low standby power**  
New PCB program to reduce 20% standby power consumption

### Low Noise Level

- **Night mode operation function**  
Quiet Night Mode (-8 dB(A)) is also available by setting PCB  
Noise can be reduced to 50 dB(A)

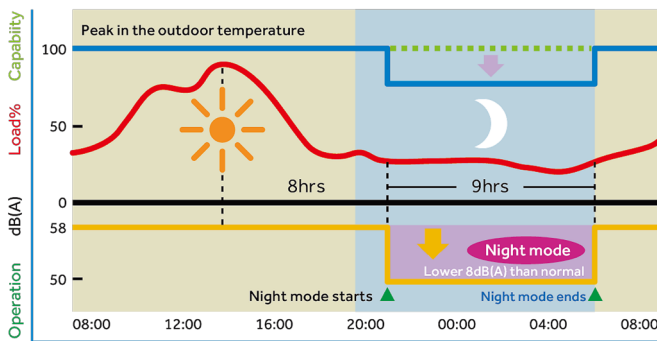

### New DC inverter with twin rotary compressor

Small torque changes & good dynamic balance allows the system to run stably, with little vibration, low noise and higher efficiency when running partial load

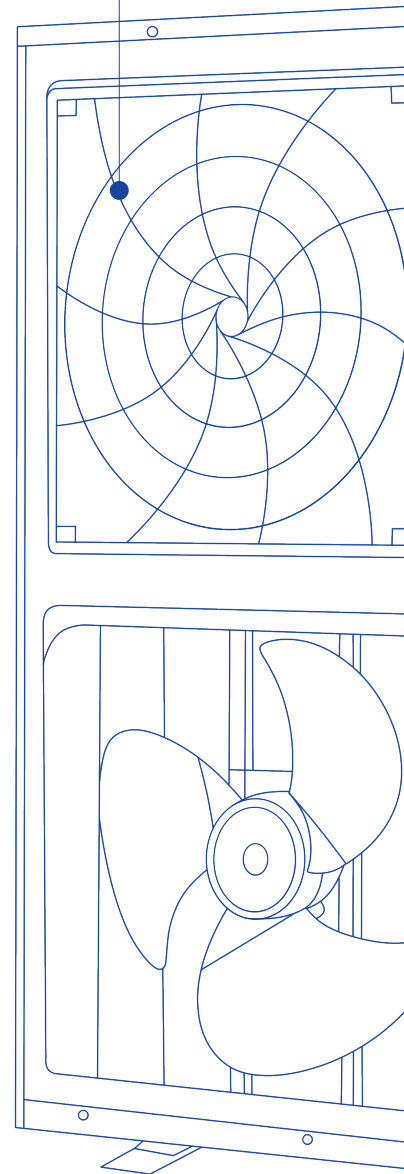
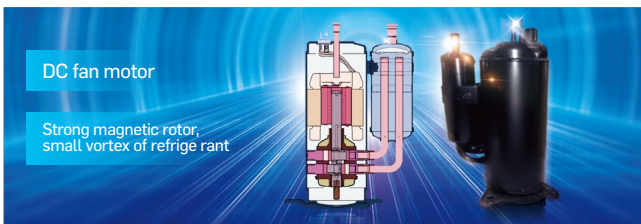



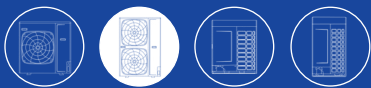

### Super Comfort

- 1 **Enlarged air inlet path and spiral air outlet**  
Air flow follows the grill direction to lower sound level by 2-4 dB(A)
- 2 **Automatic sound-lowering program**  
Night mode set by PCB to lower sound level by 8dB (A)

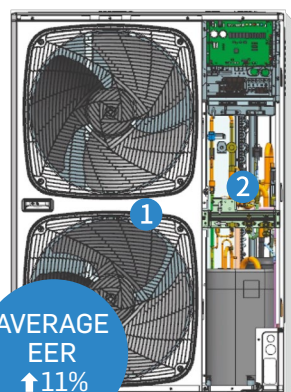

- **Vector inverter control - more precise**
- **DC fan motor bracket & non-resonance structure**  
Ensures smooth running of the motor to reduce operating noise
- **DC inverter twin rotary compressor**  
Smooth operation with no need to frequently start the compressor effectively reduces the outdoor noise
- **Big diameter fan**  
Design according to the aviation quieter principle

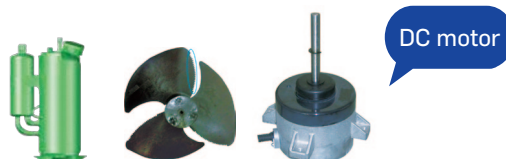



## Carrier Product Benefits

4/5/6 HP

8/10/12 HP



### Easy Installation

- 1 **Double side '4' handles**  
Easy to carry
- 2 **'888' test panel**  
All running data and error codes can be checked from '888' screen, which is easy for installers
- 3 **Four-way pipe connection**  
Four-way (front, back, left and right) pipe connection, easy to design and install

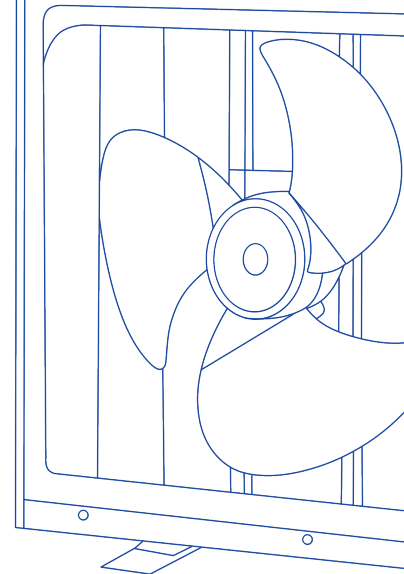
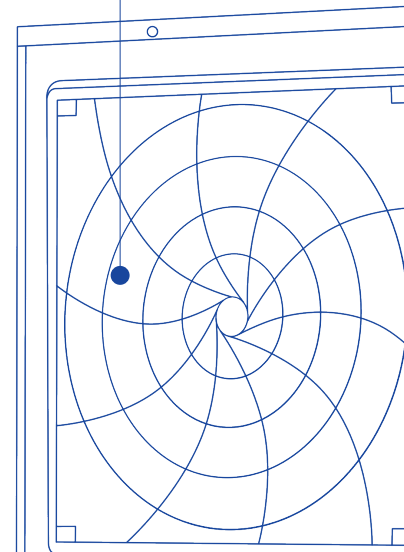
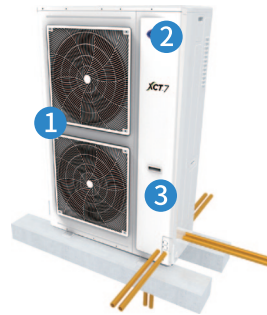

Outdoor

### • Compact Discharge Design

Big capacity, small footprint with only 0.42 m<sup>2</sup>, to reduce floor area by as much as 43%. No need for an additional ventilation hood as compared to the top discharge unit.

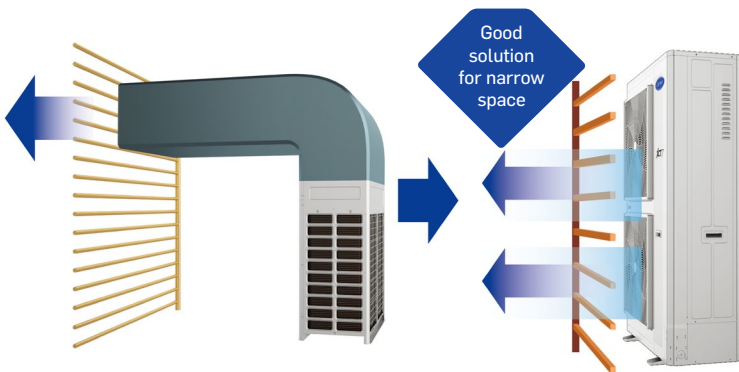

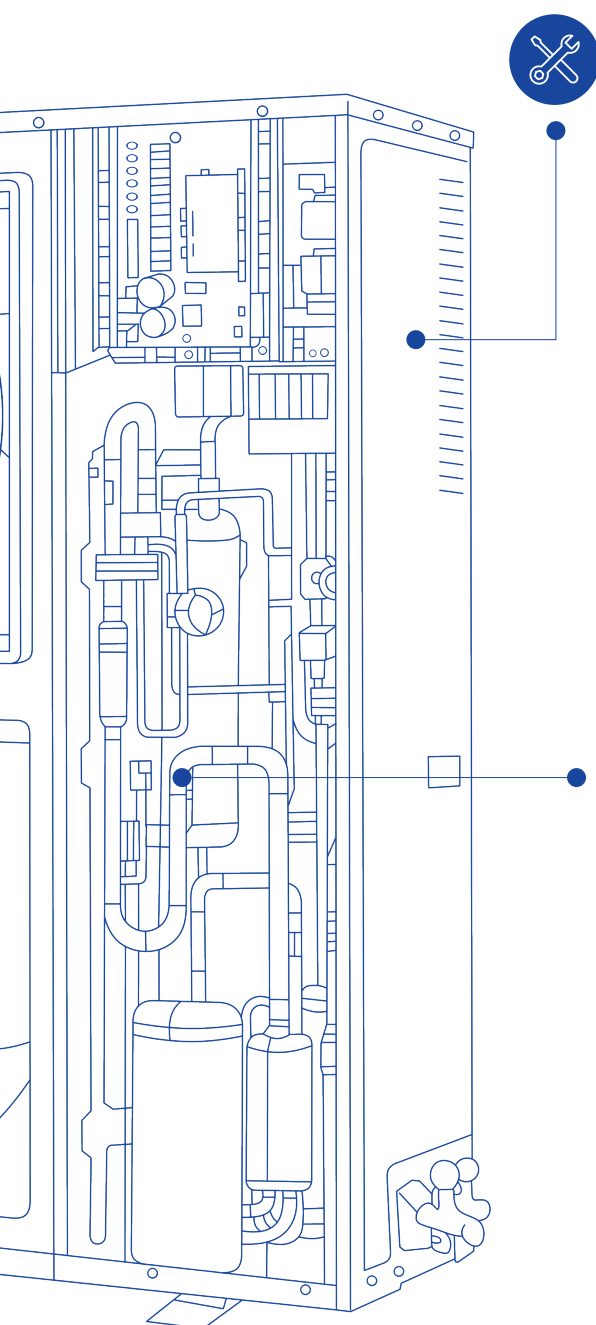

### Easy Maintenance for Control

- **Front-facing, hinge design control box**

Reserving space by 108 mm between control box and top panel, the easy-to-open unit allows for maintenance from the top



Refrigerant charging valve

Outdoor

- **Parameter display panel**

The first original parameter display panel is on the side

The parameter can be observed directly by opening the protective cover

No need to remove the repair board

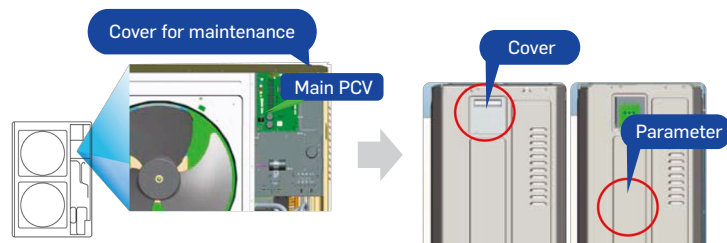





## Carrier Product Benefits

4/5/6 HP

8/10/12 HP



### Easy Maintenance for Control

The control box is in front, reserving 108 mm between the control box and top panel, and along with the hinge design, allows for easy maintenance from the top

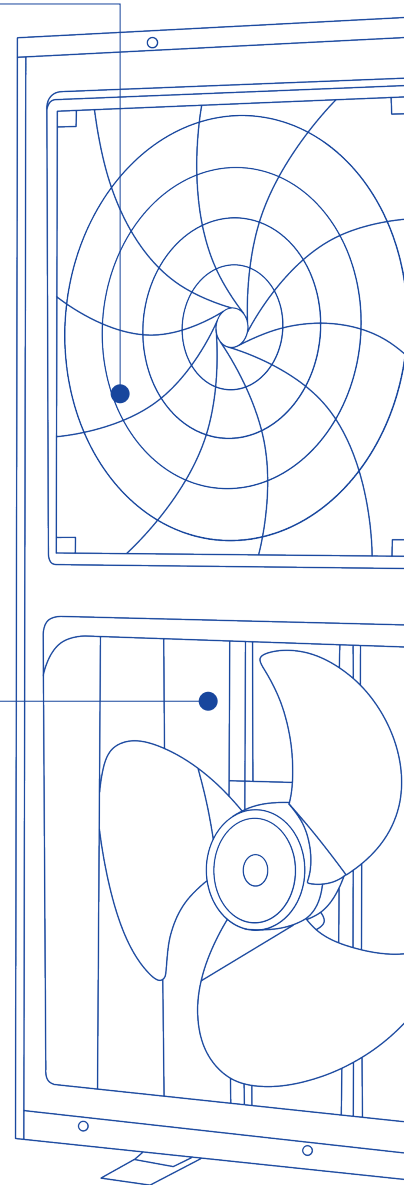
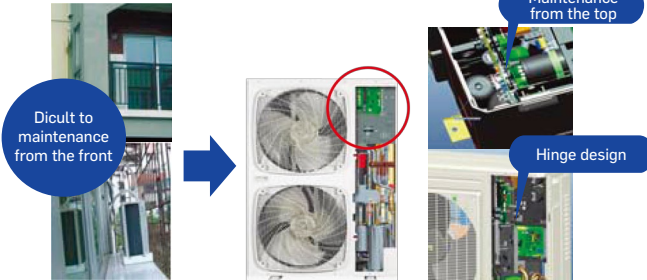

- **Air inlet grill design on right side panel**

This is to effectively reduce the module temperature and avoid air dust entering the air conditioner

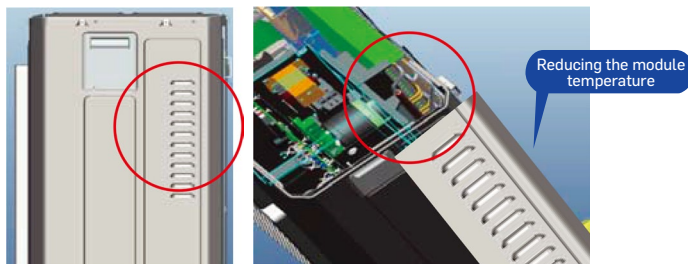

Outdoor



### High Reliability

- **Refrigerant control technology**

Refrigerant control technology without high pressure accumulator reduces the refrigerant volume and enhances the running efficiency

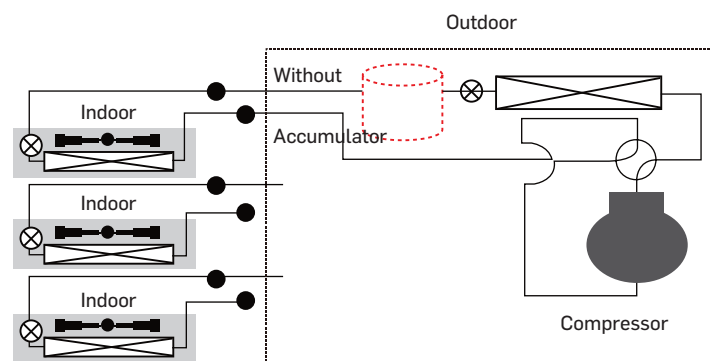

- **High and low double pressure sensor**

Double pressure sensors with PID control technology together with high speed communication allow quicker start of compressor and the more precise control.

The temperature can be controlled  $\pm 0.5^{\circ}\text{C}$

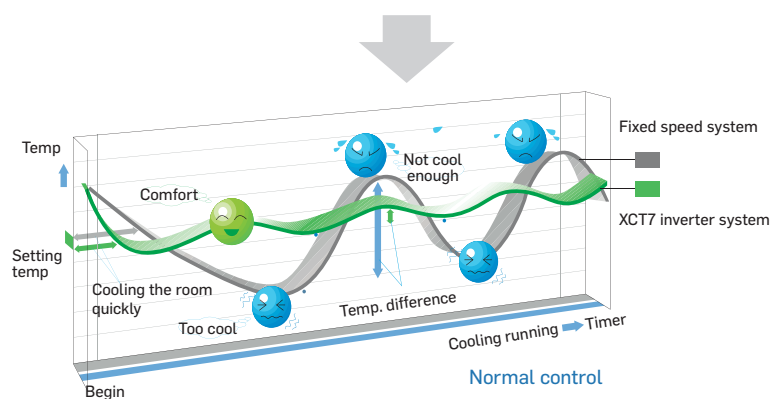



## Specifications

### 1-Ph

Model			38VS12117SHQEE	38VS14017SHQEE	38VS15517SHQEE
Capacity <sup>(1)</sup>	Capacity Range	HP	4	5	6
	Cooling	kW	12,1	14,0	15,5
	Heating	kW	14,2	16,0	18,0
Cooling Efficiency <sup>(1)</sup>	EER	W/W	4,05	3,99	3,60
	SEER	/	6,82	6,63	6,45
	ηs	%	269,8	262,2	255
Heating Efficiency <sup>(1)</sup>	COP	W/W	4,47	4,30	4,10
	SCOP	/	3,92	3,85	3,8
	ηs	%	153,8	151	149
Electrical Parameters	Power supply	Ph/V/Hz	1/220-240/50/60	1/220-240/50/60	1/220-240/50/60
	Rated power input (Cooling)	kW	2,99	3,51	4,31
	Rated power input (Heating)	kW	3,18	3,72	4,39
Dimensions (H/W/D)	External	mm	950/370/1340	950/370/1340	950/370/1340
	Shipping	mm	1023/471/1420	1023/471/1420	1023/471/1420
Weight	Net/Shipping	kg	108/123	108/123	108/123
Compressor	Compressor type	/	Inverter Twin Rotary	Inverter Twin Rotary	Inverter Twin Rotary
	Motor power	W	4130	4130	4130
	Compressor quantity	/	1	1	1
Fan	Air flow (H)	m <sup>3</sup> /h	7200	7200	7200
Pressure Sound Level	Cooling	dB(A)	57	58	59
	Heating	dB(A)	57	58	59
Power Sound Level	Cooling	dB(A)	69	71	73
	Heating	dB(A)	71	73	75
Refrigerant	Type	/	R410A	R410A	R410A
	Charge	kg	4	4	4
Piping	Refrigerant liquid pipe (∅)	mm	9,52	9,52	9,52
	Refrigerant gas pipe (∅)	mm	15,88	15,88	15,88
	Total pipe length	m	300	300	300
	Max. pipe length (Equivalent/Actual)	m	175/150	175/150	175/150
	Max drop between IDU & ODU (ODU above/below)	m	50 / 40	50 / 40	50 / 40
	Max drop between IDU & IDU	m	15	15	15
Connection Ratio <sup>(2)</sup>	Connectable indoor unit ratio	%	50-130	50-130	50-130
	Maximum number of indoor units	/	8	10	13
Working Temp.	Cooling	°C	-15-48	-15-48	-15-48
	Heating	°C	-20-27	-20-27	-20-27



(1) All the specifications are tested under nominal condition as per Eurovent conditions (In cooling, Indoor temp is 27°C DB/19°C WB; Outdoor temp 35°C DB/24°C WB; In heating, Indoor temp is 20°C DB, Outdoor temp is 7°C DB/6°C WB)  
 CARRIER SCS participates in the ECP program for Comfort Air Conditioner (AC).  
 Check ongoing validity of certificate [www.eurovent-certification.com](http://www.eurovent-certification.com)

(2) The indoor and outdoor capacity ratio should be limited within 100% when all the indoor units are in operation to ensure the system cooling/heating performance.



## Side Discharge Heat Pump 4-5-6 HP

### 3-Ph



Model		38VS121173HQEE	38VS140173HQEE	38VS155173HQEE	
Capacity <sup>(1)</sup>	Capacity Range	HP	4	5	6
	Cooling	kW	12,1	14,0	15,5
	Heating	kW	14,2	16,0	18,0
Cooling Efficiency <sup>(1)</sup>	EER	W/W	4,05	3,99	3,60
	SEER	/	6,82	6,63	6,45
	η <sub>s</sub>	%	269,8	262,2	255
Heating Efficiency <sup>(1)</sup>	COP	W/W	4,47	4,30	4,10
	SCOP	/	3,92	4,17	3,8
	η <sub>s</sub>	%	153,8	151	149
Electrical Parameters	Power supply	Ph/V/Hz	3/380-415/50/60	3/380-415/50/60	3/380-415/50/60
	Rated power input (Cooling)	kW	2,99	3,51	4,31
	Rated power input (Heating)	kW	3,18	3,72	4,39
Dimensions (H/W/D)	External	mm	950/370/1340	950/370/1340	950/370/1340
	Shipping	mm	1023/471/1420	1023/471/1420	1023/471/1420
Weight	Net/Shipping	kg	108/123	108/123	108/123
Compressor	Compressor type	/	Inverter Twin Rotary	Inverter Twin Rotary	Inverter Twin Rotary
	Motor power	W	4060	4060	4060
	Compressor quantity	/	1	1	1
Fan	Air flow (H)	m <sup>3</sup> /h	7200	7200	7200
Pressure Sound Level	Cooling	dB(A)	57	58	59
	Heating	dB(A)	57	58	59
Power Sound Level	Cooling	dB(A)	69	71	73
	Heating	dB(A)	71	73	75
Refrigerant	Type	/	R410A	R410A	R410A
	Charge	kg	4	4	4
Piping	Refrigerant liquid pipe (∅)	mm	9,52	9,52	9,52
	Refrigerant gas pipe (∅)	mm	15,88	15,88	15,88
	Total pipe length	m	300	300	300
	Max. pipe length (Equivalent/Actual)	m	175/150	175/150	175/150
	Max drop between IDU & ODU (ODU above/below)	m	50 / 40	50 / 40	50 / 40
	Max drop between IDU & IDU	m	15	15	15
Connection Ratio <sup>(2)</sup>	Connectable indoor unit ratio	%	50-130	50-130	50-130
	Maximum number of indoor units	/	8	10	13
Working Temp.	Cooling	°C	-15-48	-15-48	-15-48
	Heating	°C	-20-27	-20-27	-20-27



(1) All the specifications are tested under nominal condition as per Eurovent conditions (In cooling, Indoor temp is 27°C DB/19°C WB; Outdoor temp 35°C DB/24°C WB; In heating, Indoor temp is 20°C DB, Outdoor temp is 7°C DB/6°C WB)  
 CARRIER SCS participates in the ECP program for Comfort Air Conditioner (AC).  
 Check ongoing validity of certificate [www.eurovent-certification.com](http://www.eurovent-certification.com)

(2) The indoor and outdoor capacity ratio should be limited within 100% when all the indoor units are in operation to ensure the system cooling/heating performance.



Specifications

Side Discharge Heat Pump 8-10-12 HP

Model			38VS226174HQEE	38VS280174HQEE	38VS335174HQEE
Capacity <sup>(1)</sup>	Capacity Range	HP	8	10	12
	Cooling	kW	22,6	28	31,5
	Heating	kW	22,6	30,5	31,5
	Max Heating	kW	25,0	32,0	35,0
Cooling Efficiency <sup>(1)</sup>	EER	W/W	3,5	3,2	3,1
	SEER	/	8,5	8,2	7,7
	ηs	%	337	325	305
Heating Efficiency <sup>(1)</sup>	COP	W/W	3,9	3,8	3,7
	SCOP	/	5	4,8	4,7
	ηs	%	197	189	185
Electrical Parameters	Power supply	Ph/V/Hz	3/380-415/50/60	3/380-415/50/60	3/380-415/50/60
	Rated power input (Cooling)	kW	6,46	8,75	10,16
	Rated power input (Heating)	kW	5,79	8,03	8,51
Dimensions (H/W/D)	External	mm	1050/400/1636	1050/400/1636	1050/400/1636
	Shipping	mm	1150/510/1790	1150/510/1790	1150/510/1790
Weight	Net/Shipping	kg	149/168	149/168	149/168
Compressor	Compressor type	/	Inverter Twin Rotary	Inverter Twin Rotary	Inverter Twin Rotary
	Motor power	W	6270	6270	6270
	Compressor quantity	/	1	1	1
Fan	Air flow (H)	m <sup>3</sup> /h	10000	10000	10000
Pressure Sound Level	Cooling	dB(A)	63	64	65
	Heating	dB(A)	65	66	67
Power Sound Level	Cooling	dB(A)	74	75	76
	Heating	dB(A)	76	77	78
Refrigerant	Type	/	R410A	R410A	R410A
	Charge	kg	5,1	5,1	5,1
Piping	Refrigerant liquid pipe (∅)	mm	9,52	9,52	12,7
	Refrigerant gas pipe (∅)	mm	19,05	22,22	25,4
	Total pipe length	m	300	300	300
	Max. pipe length (Equivalent/Actual)	m	175/150	175/150	175/150
	Max drop between IDU & ODU (ODU above/below)	m	50 / 40	50 / 40	50 / 40
	Max drop between IDU & IDU	m	15	15	15
Connection Ratio	Connectable indoor unit ratio <sup>(2)</sup>	%	50-130	50-130	50-130
	Maximum number of indoor units	/	13	16	19
Working Temp.	Cooling	°C	-5-48	-5-48	-5-48
	Heating	°C	-20-27	-20-27	-20-27



(1) All the specifications are tested under nominal condition as per Eurovent conditions (In cooling, Indoor temp is 27°C DB/19°C WB; Outdoor temp 35°C DB/24°C WB; In heating, Indoor temp is 20°C DB, Outdoor temp is 7°C DB/6°C WB)  
 CARRIER SCS participates in the ECP program for Comfort Air Conditioner (AC).  
 Check ongoing validity of certificate [www.eurovent-certification.com](http://www.eurovent-certification.com)

(2) The indoor and outdoor capacity ratio should be limited within 100% when all the indoor units are in operation to ensure the system cooling/heating performance.

## Side Discharge Heat Pump 4-5HP



Model			38VS125C7SHQEE	38VS140C7SHQEE
Capacity <sup>(1)</sup>	Capacity Range	HP	4	5
	Cooling	kW	12,1	14,0
	Heating	kW	12,1	14,0
	Heating (Max)	kW	14,0	15,5
Cooling Efficiency <sup>(1)</sup>	EER	W/W	2,85	2,80
	SEER	/	4,90	4,85
	ηs	%	193	191
Heating Efficiency <sup>(1)</sup>	COP	W/W	2,95	2,90
	SCOP <sup>(1)</sup>	/	3,50	3,55
	ηs	%	137	139
Electrical Parameters	Power supply	Ph/V/Hz	1/220-240/50/60	1/220-240/50/60
	Rated Power input (Cooling)	kW	4,25	5,00
	Rated Power input (Heating)	kW	4,10	4,83
Dimensions (H/W/D)	External	mm	950×370×965	950×370×965
	Shipping	mm	1010×458×990	1010×458×990
Weight	Net/Shipping weight	kg	90/97	90/97
Compressor	Compressor type	/	Inverter Twin Rotary	Inverter Twin Rotary
	Motor Power	W	4130	4130
	Compressor quantity	/	1	1
Fan	Air flow (H)	m <sup>3</sup> /h	5400	5400
Pressure Sound Level	Cooling	dB(A)	58	60
	Heating	dB(A)	60	62
Power Sound Level	Cooling	dB(A)	69	71
	Heating	dB(A)	71	73
Refrigerant	Type	/	R410A	R410A
	Charge	kg	3,3	3,3
Piping	Refrigerant liquid pipe (∅)	mm	9.52	9.52
	Refrigerant gas pipe (∅)	mm	15.88	15.88
	Total pipe length	m	120	120
	Max. pipe length (Equivalent/Actual)	m	70/60	70/60
	Max drop between I.U.&O.U (ODU above / below)	m	30/20	30/20
	Max drop between I.U.&I.U	m	10	10
Connection Ratio	Connectable indoor unit ratio <sup>(2)</sup>	%	50-130	50-130
	Maximum number of indoor units	/	7	8
Working Temp.	Cooling	°C	-5-52	-5-52
	Heating	°C	-15-21	-15-21



(1) All the specifications are tested under nominal condition as per Eurovent conditions (In cooling, Indoor temp is 27°C DB/19°C WB; Outdoor temp 35°C DB/24°C WB; In heating, Indoor temp is 20°C DB, Outdoor temp is 7°C DB/6°C WB)  
 CARRIER SCS participates in the ECP program for Comfort Air Conditioner (AC).  
 Check ongoing validity of certificate [www.eurovent-certification.com](http://www.eurovent-certification.com)

(2) The indoor and outdoor capacity ratio should be limited within 100% when all the indoor units are in operation to ensure the system cooling/heating performance.





Turn to the experts



### Dimensions (4-6HP)

4/5 HP Single Fan Side Discharge

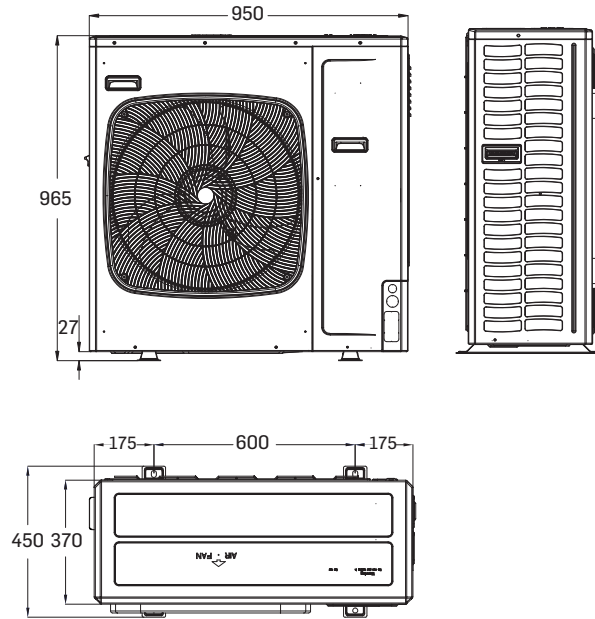

4/5/6 HP Dual Fan Side Discharge

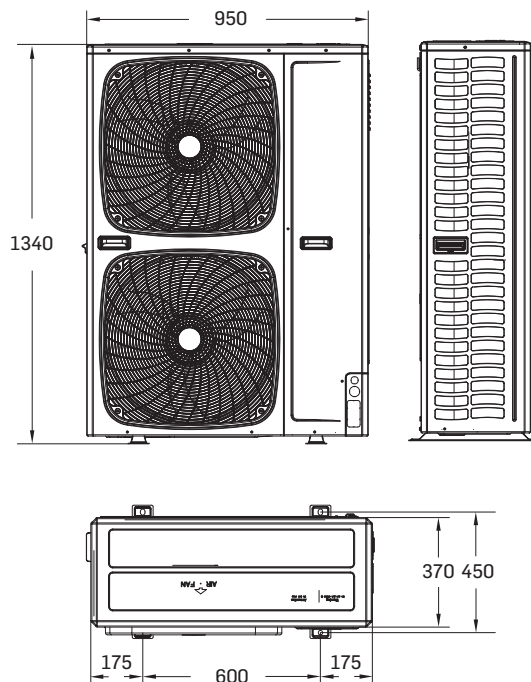

Outdoor

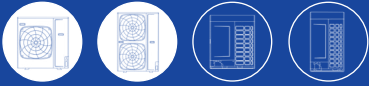

### Dimensions (8-12HP)

8/10/12 HP Dual Fan Side Discharge

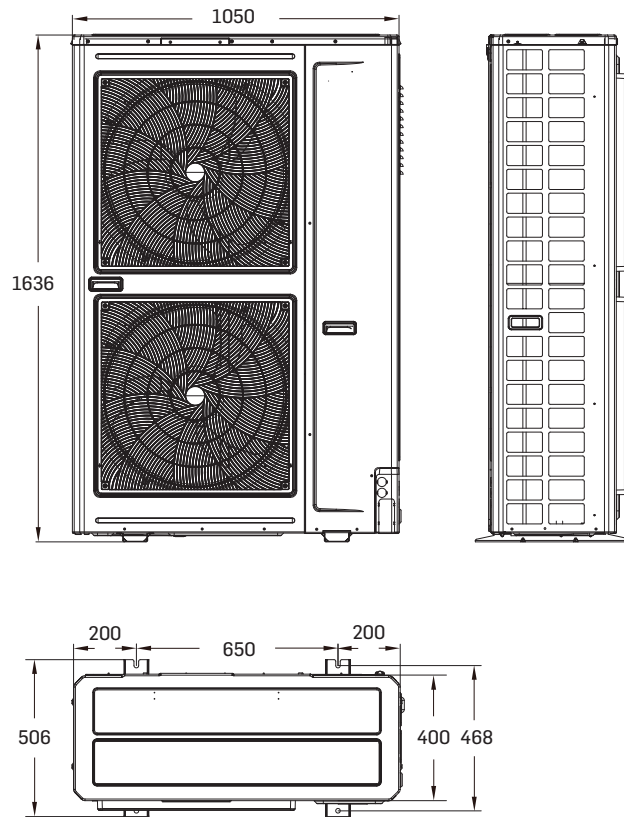

Outdoor



Turn to the experts



Outdoor





# TOP DISCHARGE

Handles heating and cooling with incredible efficiency and ensures continuous comfort indoors



Turn to the experts

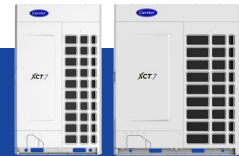

## XCT7 Unit Special Features



### One Button Trial Operation

You only need to press the outdoor PCB button once to initiate the trial operation mode instead of starting indoor units one by one.

Save up to 10% of trial operation time with this unique function for both cooling/heating modes.



Outdoor

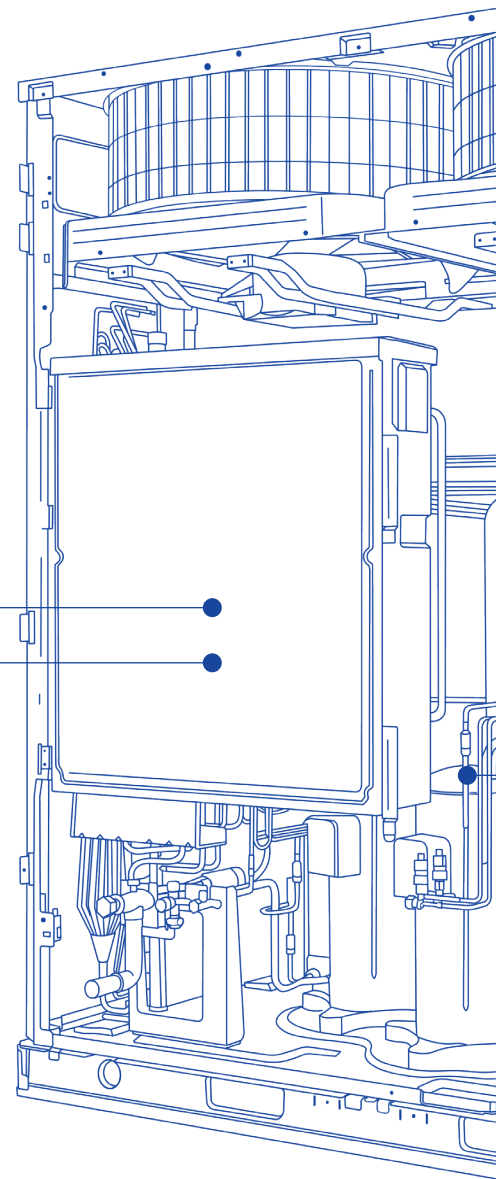

### Less Brazing Refrigerant Accessories

The refrigerant piping accessories are pre-fitted with multiple diameters for you to simply cut depending on your needs.



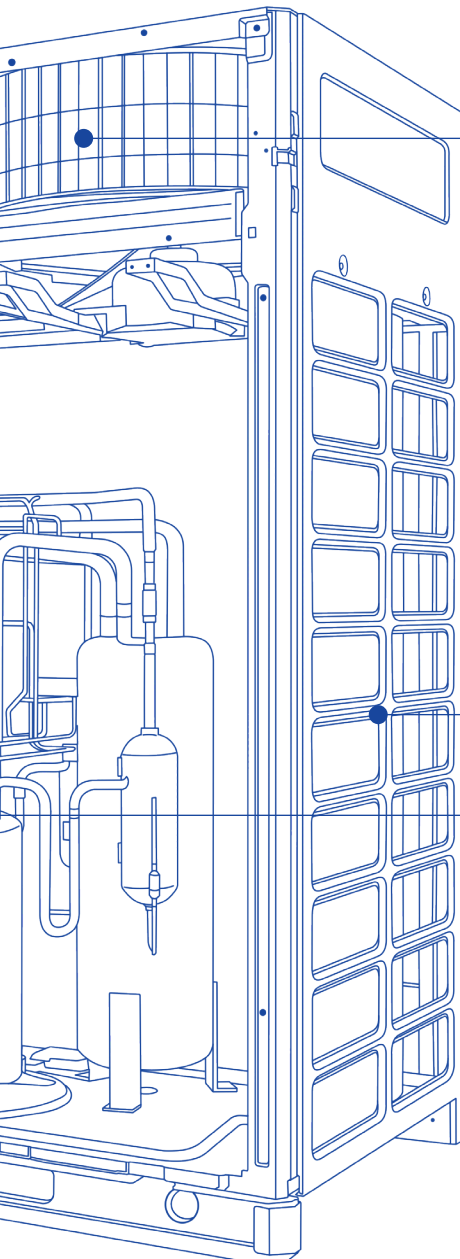

### High Efficiency Outdoor Fan & Dc Inverter Stepless Fan Motor

The fan adopts an aerodynamic design for low noise and high efficiency.

The outdoor fan motor adopts unique stepless inverter regulation technology, which coordinates with the stepless inverter compressor.



### Advanced black-coated fin Technology

The unique advanced black-coated fin technology on the outdoor condenser enhances corrosion resistance and provides stronger protection from air pollution and salt contamination to achieve maximum system reliability.



### Advanced Separator

Our advanced separator enhances heat exchanger performance, improves refrigerant distribution balance, and increases overall system efficiency.





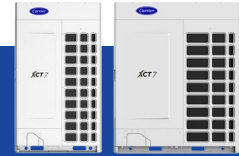

## XCT7 Unit Special Features



### Reliable Multi-layer Oil Return Technology

Our 10-stage oil return technology, as compared to the industry average of 5, ensures smooth lubricant oil supply to protect the compressor and system.

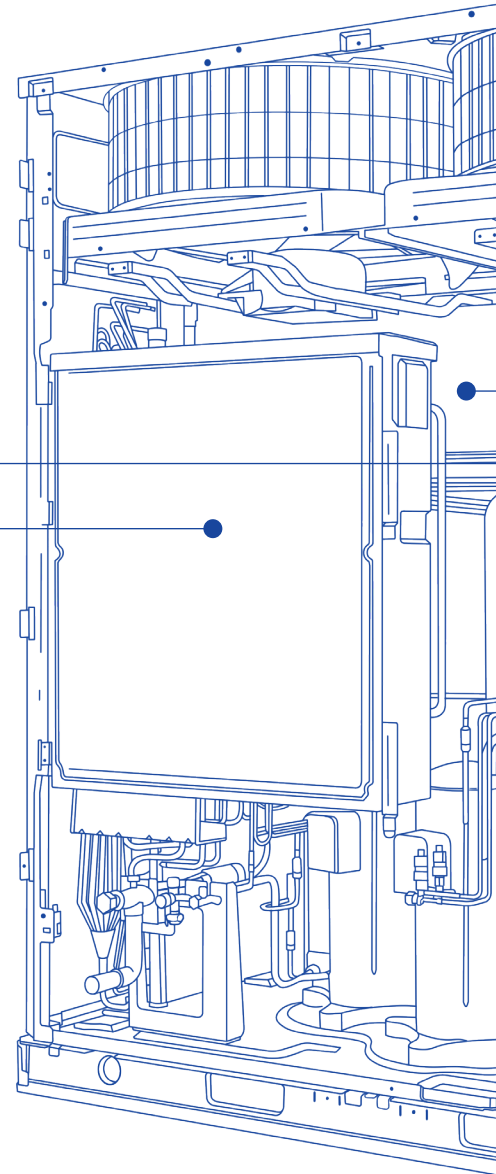
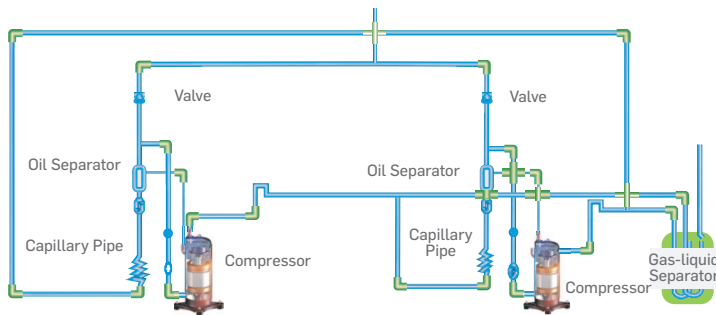

Outdoor



### Advanced Compressor Anti-liquid shock Technology

With a soft scroll design, the anti-liquid shock technology ensures an effective unloading when the compressor's internal pressure is too large. It also assures reliable and efficient operation of the compressor by reducing friction and leakage loss and halving the liquid shock failure rate.

General working principle

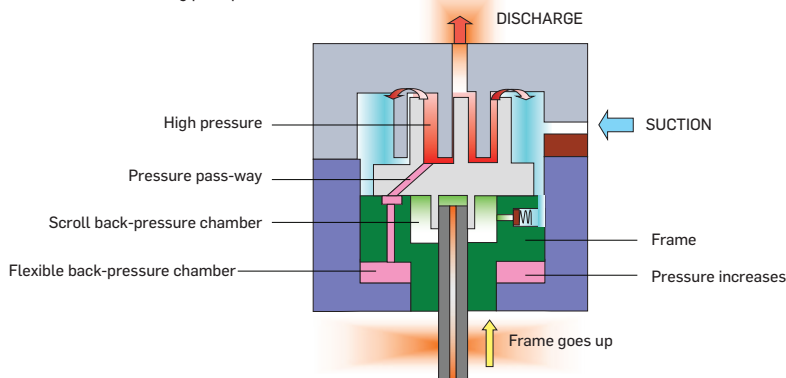

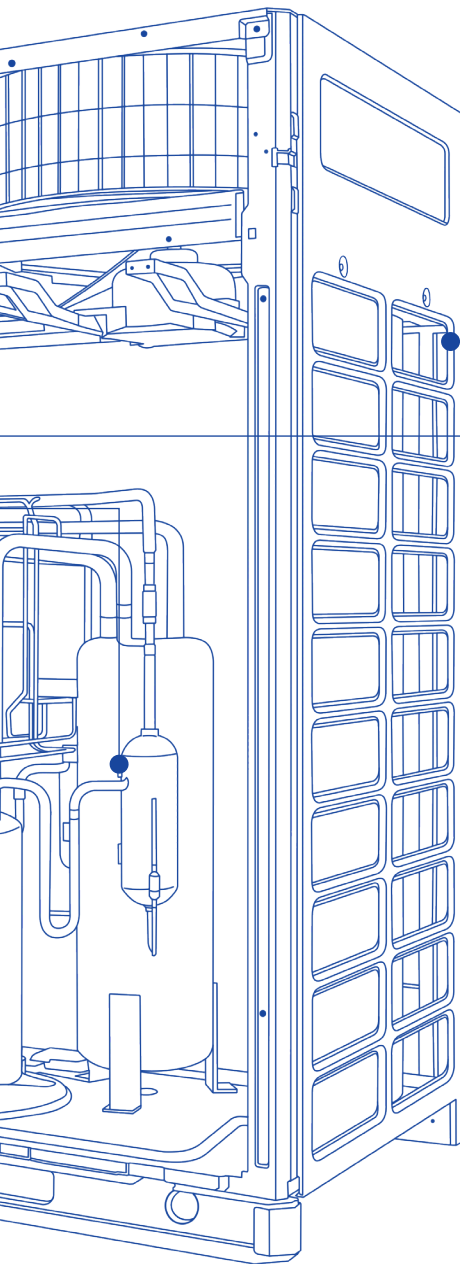

### Easy Access

The design of the ODU is optimized to open to 120°, allowing complete access to internal system components.



### Flexible Long Piping Length

The piping can go up to 1000 m in length and a maximum of 110 m in height, thereby allowing you to easily serve in high rise buildings.

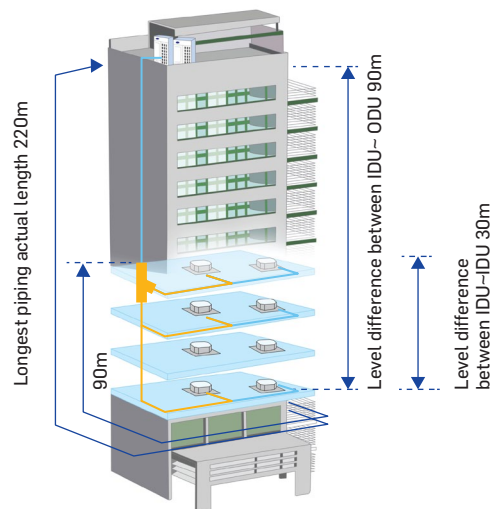

The first indoor unit branch

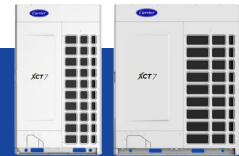

## Specifications

Model			38VT008173HQEE	38VT010173HQEE	38VT012173HQEE	38VT014173HQEE	38VT016173HQEE
Capacity		HP	8	10	12	14	16
Capacity <sup>(1)</sup>	Cooling	kW	25,2	28,0	33,5	40,0	45,0
	Heating	kW	25,2	28,0	33,5	40,0	45,0
Cooling Efficiency <sup>(1)</sup>	EER	W/W	4,04	3,8	3,6	3,35	3,4
	SEER	/	7,25	7,09	6,69	6,6	6,36
	ηs	%	287	281	265	261	251
Heating Efficiency <sup>(1)</sup>	COP	W/W	4,4	4,3	4,22	4	4
	SCOP <sup>(1)</sup>	/	4,5	4,4	4,4	4,2	4
	ηs	%	177	173	173	165	157
Electrical Parameters	Power supply	Ph/V/Hz	3/380-415/50/60	3/380-415/50/60	3/380-415/50/60	3/380-415/50/60	3/380-415/50/60
	Rated power input (Cooling)	kW	6,24	7,37	9,31	11,94	13,24
	Rated power input (Heating)	kW	5,73	6,51	7,94	10,00	11,25
Dimensions (H/W/D)	External	mm	980/750/1690	980/750/1690	980/750/1690	980/750/1690	980/750/1690
	Shipping	mm	1070/850/1858	1070/850/1858	1070/850/1858	1070/850/1858	1070/850/1858
Weight	Net/Shipping	kg	224/250	224/250	224/250	244/270	244/270
Compressor	Type	/	DC INV. SCROLL	DC INV. SCROLL	DC INV. SCROLL	DC INV. SCROLL	DC INV. SCROLL
	Motor power	W	6500	6500	6500	6500	7640
	Compressor quantity	/	1 INV	1 INV	1 INV	1 INV	1 INV
Fan	Air flow	m³/h	11000	11000	12000	13500	13500
Pressure Sound Level <sup>(1)</sup>	Cooling	dB(A)	56	56	59	59	60
	Heating	dB(A)	56	56	59	59	60
Power Sound Level <sup>(1)</sup>	Cooling	dB(A)	81	82	88	88	88
	Heating	dB(A)	81	82	88	88	88
Refrigerant	Type	/	R410A	R410A	R410A	R410A	R410A
	Charge	kg	8,5	8,5	8,5	10	10
Piping	Refrigerant liquid pipe (∅)	mm	9,52	9,52	12,7	12,7	12,7
	Refrigerant gas pipe (∅)	mm	19,05	22,22	25,4	25,4	28,58
	Total pipe length	m	1000	1000	1000	1000	1000
	Max. pipe length (Equivalent/Actual)	m	260/220	260/220	260/220	260/220	260/220
	Max drop between I.U.&O.U (ODU Below/Above)	m	110/90	110/90	110/90	110/90	110/90
	Max drop between I.U.&I.U	m	30	30	30	30	30
Connectivity Ratio <sup>(2)</sup>	Connectable indoor unit ratio	%	50-130	50-130	50-130	50-130	50-130
	Maximum number of indoor units	/	13	16	20	24	27
Operating Range	Cooling	°C	-5-50	-5-50	-5-50	-5-50	-5-50
	Heating	°C	-23-21	-23-21	-23-21	-23-21	-23-21



(1) All the specifications are tested under nominal condition as per Eurovent conditions (In cooling, Indoor temp is 27°C DB/19°C WB; Outdoor temp 35°C DB/24°C WB; In heating, Indoor temp is 20°C DB, Outdoor temp is 7°C DB/6°C WB)

CARRIER SCS participates in the ECP program for Comfort Air Conditioner (AC).

Check ongoing validity of certificate [www.eurovent-certification.com](http://www.eurovent-certification.com)

(2) The indoor and outdoor capacity ratio should be limited within 100% when all the indoor units are in operation to ensure the system cooling/heating performance.

## Top Discharge Heat Pump 8-26 HP



Model			38VT018173HQEE	38VT020173HQEE	38VT022173HQEE	38VT024173HQEE	38VT026173HQEE
Capacity		HP	18	20	22	24	26
Capacity <sup>(1)</sup>	Cooling	kW	50,4	56,0	61,5	68,0	73,5
	Heating	kW	50,4	56,0	61,5	68,0	73,5
Cooling Efficiency <sup>(1)</sup>	EER	W/W	3,21	3,37	3,36	3,1	2,97
	SEER	/	6,78	6,75	6,54	5,97	5,68
	ηs	%	268	267	259	236	224
Heating Efficiency <sup>(1)</sup>	COP	W/W	3,82	3,82	3,7	3,5	3,3
	SCOP <sup>(1)</sup>	/	4,23	4,29	4,3	4,25	3,8
	ηs	%	166,2	168,6	169	167	149
Electrical Parameters	Power supply	Ph/V/Hz	3/380-415/50/60	3/380-415/50/60	3/380-415/50/60	3/380-415/50/60	3/380-415/50/60
	Rated power input (Cooling)	kW	15,70	16,62	18,30	21,94	24,75
	Rated power input (Heating)	kW	13,19	14,66	16,62	19,43	22,27
Dimensions (H/W/D)	External	mm	1410/750/1690	1410/750/1690	1410/750/1690	1410/750/1690	1410/750/1690
	Shipping	mm	1515/850/1858	1515/850/1858	1515/850/1858	1515/850/1858	1515/850/1858
Weight	Net/Shipping	kg	287/317	370/400	370/400	370/400	370/400
Compressor	Type	/	DC INV. SCROLL	DC INV. SCROLL	DC INV. SCROLL	DC INV. SCROLL	DC INV. SCROLL
	Motor power	W	8500	5250*2	6500*2	6500*2	7640*2
	Compressor quantity	/	1 INV	2 INV	2 INV	2 INV	2 INV
Fan	Air flow	m³/h	17000	17000	18000	18000	19000
Pressure Sound Level <sup>(1)</sup>	Cooling	dB(A)	61	61	61	62	62
	Heating	dB(A)	61	61	61	62	62
Power Sound Level <sup>(1)</sup>	Cooling	dB(A)	88	88	90	90	90
	Heating	dB(A)	88	88	90	90	90
Refrigerant	Type	/	R410A	R410A	R410A	R410A	R410A
	Charge	kg	10	10	10	10	10
Piping	Refrigerant liquid pipe (∅)	mm	15,88	15,88	15,88	15,88	15,88
	Refrigerant gas pipe (∅)	mm	28,58	28,58	28,58	28,58	28,58
	Total pipe length	m	1000	1000	1000	1000	1000
	Max. pipe length (Equivalent/Actual)	m	260/220	260/220	260/220	260/220	260/220
	Max drop between I.U.&O.U (ODU Below/Above)	m	110/90	110/90	110/90	110/90	110/90
	Max drop between I.U.&I.U	m	30	30	30	30	30
Connectivity Ratio <sup>(2)</sup>	Connectable indoor unit ratio	%	50-130	50-130	50-130	50-130	50-130
	Maximum number of indoor units	/	30	33	36	40	43
Operating Range	Cooling	°C	-5-50	-5-50	-5-50	-5-50	-5-50
	Heating	°C	-23-21	-23-21	-23-21	-23-21	-23-21



(1) All the specifications are tested under nominal condition as per Eurovent conditions (In cooling, Indoor temp is 27°C DB/19°C WB; Outdoor temp 35°C DB/24°C WB; In heating, Indoor temp is 20°C DB, Outdoor temp is 7°C DB/6°C WB)  
 CARRIER SCS participates in the ECP program for Comfort Air Conditioner (AC).  
 Check ongoing validity of certificate [www.eurovent-certification.com](http://www.eurovent-certification.com)

(2) The indoor and outdoor capacity ratio should be limited within 100% when all the indoor units are in operation to ensure the system cooling/heating performance.





Turn to the experts



## Specifications

Model			2 Modules						
Model Code			38VT028S73HQEE	38VT030S73HQEE	38VT032S73HQEE	38VT034S73HQEE	38VT036S73HQEE	38VT038S73HQEE	38VT040S73HQEE
Capacity	HP		28	30	32	34	36	38	40
Combination			14+14	14+16	16+16	16+18	18+18	18+20	20+20
Combination Model Codes			38VT014173HQEE	38VT014173HQEE	38VT016173HQEE	38VT016173HQEE	38VT018173HQEE	38VT018173HQEE	38VT020173HQEE
			38VT014173HQEE	38VT016173HQEE	38VT016173HQEE	38VT018173HQEE	38VT018173HQEE	38VT020173HQEE	38VT020173HQEE
			/	/	/	/	/	/	/
			/	/	/	/	/	/	/
Capacity	Cooling	kW	80,0	85,0	90,0	95,4	100,8	106,4	112,0
	Heating	kW	80,0	85,0	90,0	95,4	100,8	106,4	112,0
Cooling Efficiency	EER	W/W	3,35	3,38	3,40	3,30	3,21	3,29	3,37
	SEER		6,60	6,47	6,36	6,57	6,78	6,76	6,75
Heating Efficiency	COP	W/W	4,00	4,00	4,00	3,90	3,82	3,82	3,82
	SCOP	/	4,17	4,08	4,01	4,13	4,23	4,26	4,29
Maximum Number of Indoor Units	/		47	50	53	56	59	63	64

Model			3 Modules						
Model Code			38VT054S73HQEE	38VT056S73HQEE	38VT058S73HQEE	38VT060S73HQEE	38VT062S73HQEE	38VT064S73HQEE	38VT066S73HQEE
Capacity	HP		54	56	58	60	62	64	66
Combination			18+18+18	18+18+20	18+20+20	20+20+20	22+20+20	22+22+20	22+22+22
Combination Model Codes			38VT018173HQEE	38VT018173HQEE	38VT018173HQEE	38VT020173HQEE	38VT022173HQEE	38VT022173HQEE	38VT022173HQEE
			38VT018173HQEE	38VT018173HQEE	38VT020173HQEE	38VT020173HQEE	38VT020173HQEE	38VT022173HQEE	38VT022173HQEE
			38VT018173HQEE	38VT020173HQEE	38VT020173HQEE	38VT020173HQEE	38VT020173HQEE	38VT020173HQEE	38VT022173HQEE
			/	/	/	/	/	/	/
Capacity	Cooling	kW	151,2	156,8	162,4	168,0	173,5	179,0	184,5
	Heating	kW	151,2	156,8	162,4	168,0	173,5	179,0	184,5
Cooling Efficiency	EER	W/W	3,21	3,27	3,32	3,37	3,37	3,36	3,36
	SEER		6,78	6,76	6,75	6,75	6,67	6,60	6,54
Heating Efficiency	COP	W/W	3,82	3,82	3,82	3,82	3,78	3,74	3,70
	SCOP	/	4,23	4,25	4,27	4,29	4,29	4,29	4,30
Maximum Number of Indoor Units	/		64	64	64	64	64	64	64

Model			4 Modules						
Model Code			38VT080S73HQEE	38VT082S73HQEE	38VT084S73HQEE	38VT086S73HQEE	38VT088S73HQEE	38VT090S73HQEE	38VT092S73HQEE
Capacity	HP		80	82	84	86	88	90	92
Combination			20+20+20+20	20+20+20+22	20+20+22+22	20+22+22+22	22+22+22+22	24+22+22+22	24+24+22+22
Combination Model Codes			38VT020173HQEE	38VT020173HQEE	38VT020173HQEE	38VT020173HQEE	38VT022173HQEE	38VT024173HQEE	38VT024173HQEE
			38VT020173HQEE	38VT020173HQEE	38VT020173HQEE	38VT022173HQEE	38VT022173HQEE	38VT022173HQEE	38VT024173HQEE
			38VT020173HQEE	38VT020173HQEE	38VT022173HQEE	38VT022173HQEE	38VT022173HQEE	38VT022173HQEE	38VT022173HQEE
			38VT020173HQEE	38VT022173HQEE	38VT022173HQEE	38VT022173HQEE	38VT022173HQEE	38VT022173HQEE	38VT022173HQEE
Capacity	Cooling	kW	224,0	229,5	235,0	240,5	246,0	252,5	259,0
	Heating	kW	224,0	229,5	235,0	240,5	246,0	252,5	259,0
Cooling Efficiency	EER	W/W	3,37	3,37	3,36	3,36	3,36	3,29	3,22
	SEER		6,75	6,69	6,64	6,59	6,54	6,37	6,22
Heating Efficiency	COP	W/W	3,82	3,79	3,76	3,73	3,70	3,64	3,59
	SCOP	/	4,29	4,29	4,29	4,29	4,30	4,29	4,27
Maximum Number of Indoor Units	/		64	64	64	64	64	64	64

## Top Discharge Heat Pump 28-104 HP



Model			2 Modules					
Model Code			38VT042S73HQEE	38VT044S73HQEE	38VT046S73HQEE	38VT048S73HQEE	38VT050S73HQEE	38VT052S73HQEE
Capacity	HP		42	44	46	48	50	52
Combination			20+22	22+22	22+24	24+24	24+26	26+26
Combination Model Codes			38VT020173HQEE	38VT022173HQEE	38VT022173HQEE	38VT024173HQEE	38VT024173HQEE	38VT026173HQEE
			38VT022173HQEE	38VT022173HQEE	38VT024173HQEE	38VT024173HQEE	38VT026173HQEE	38VT026173HQEE
			/	/	/	/	/	/
			/	/	/	/	/	/
Capacity	Cooling	kW	117,5	123,0	129,5	136,0	141,5	147,0
	Heating	kW	117,5	123,0	129,5	136,0	141,5	147,0
Cooling Efficiency	EER	W/W	3,36	3,36	3,22	3,10	3,03	2,97
	SEER		6,64	6,54	6,22	5,97	5,81	5,68
Heating Efficiency	COP	W/W	3,76	3,70	3,59	3,50	3,39	3,30
	SCOP	/	4,29	4,30	4,27	4,25	4,00	3,80
Maximum Number of Indoor Units	/		64	64	64	64	64	64

Model			3 Modules					
Model Code			38VT068S73HQEE	38VT070S73HQEE	38VT072S73HQEE	38VT074S73HQEE	38VT076S73HQEE	38VT078S73HQEE
Capacity	HP		68	70	72	74	76	78
Combination			22+22+24	22+24+24	24+24+24	26+24+24	26+26+24	26+26+26
Combination Model Codes			38VT022173HQEE	38VT022173HQEE	38VT024173HQEE	38VT026173HQEE	38VT026173HQEE	38VT026173HQEE
			38VT022173HQEE	38VT024173HQEE	38VT024173HQEE	38VT024173HQEE	38VT026173HQEE	38VT026173HQEE
			38VT024173HQEE	38VT024173HQEE	38VT024173HQEE	38VT024173HQEE	38VT024173HQEE	38VT026173HQEE
			/	/	/	/	/	/
Capacity	Cooling	kW	191,0	197,5	204,0	209,5	215,0	220,5
	Heating	kW	191,0	197,5	204,0	209,5	215,0	220,5
Cooling Efficiency	EER	W/W	3,26	3,18	3,10	3,05	3,01	2,97
	SEER		6,32	6,13	5,97	5,86	5,76	5,68
Heating Efficiency	COP	W/W	3,63	3,56	3,50	3,43	3,36	3,30
	SCOP	/	4,28	4,27	4,25	4,08	3,93	3,80
Maximum Number of Indoor Units	/		64	64	64	64	64	64

Model			4 Modules					
Model Code			38VT094S73HQEE	38VT096S73HQEE	38VT098S73HQEE	38VT100S73HQEE	38VT102S73HQEE	38VT104S73HQEE
Capacity	HP		94	96	98	100	102	104
Combination			24+24+24+22	24+24+24+24	26+24+24+24	26+26+24+24	26+26+26+24	26+26+26+26
Combination Model Codes			38VT024173HQEE	38VT024173HQEE	38VT026173HQEE	38VT026173HQEE	38VT026173HQEE	38VT026173HQEE
			38VT024173HQEE	38VT024173HQEE	38VT024173HQEE	38VT026173HQEE	38VT026173HQEE	38VT026173HQEE
			38VT024173HQEE	38VT024173HQEE	38VT024173HQEE	38VT024173HQEE	38VT026173HQEE	38VT026173HQEE
			38VT022173HQEE	38VT024173HQEE	38VT024173HQEE	38VT024173HQEE	38VT024173HQEE	38VT026173HQEE
Capacity	Cooling	kW	265,5	272,0	277,5	283,0	288,5	294,0
	Heating	kW	265,5	272,0	277,5	283,0	288,5	294,0
Cooling Efficiency	EER	W/W	3,16	3,10	3,06	3,03	3,00	2,97
	SEER		6,09	5,97	5,89	5,81	5,74	5,68
Heating Efficiency	COP	W/W	3,54	3,50	3,44	3,39	3,35	3,30
	SCOP	/	4,26	4,25	4,12	4,00	3,90	3,80
Maximum Number of Indoor Units	/		64	64	64	64	64	64



Turn to the experts

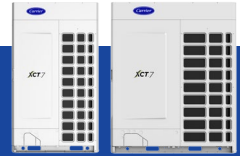

# TOP DISCHARGE HEAT RECOVERY

Outdoor







# System Introduction



## What are Heat Recovery VRF Units?

For the heat pump series, the units within one system can only work in the same mode. Now Carrier heat recovery series, due to heat recovery pipeline design of outdoor unit and the new valve box, can achieve cooling and heating simultaneously in one system. In addition, multiple indoor unit types are provided to meet various project demands.

### 2-pipe system : Top Discharge Heat Pump

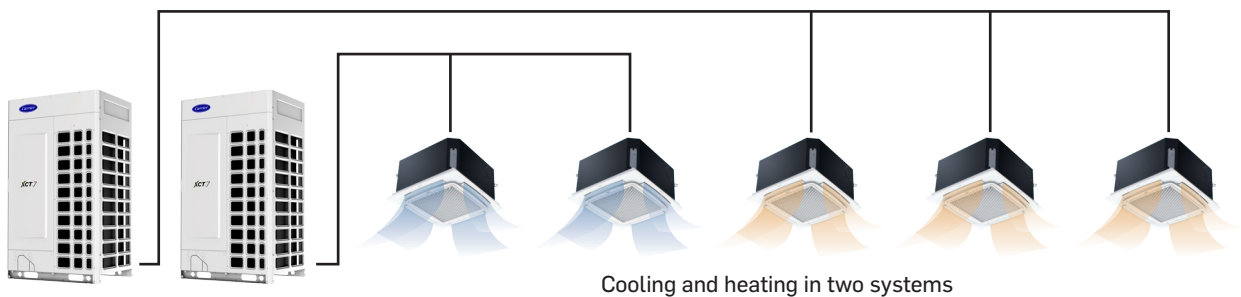

### 3-pipe system : Top Discharge Heat Recovery

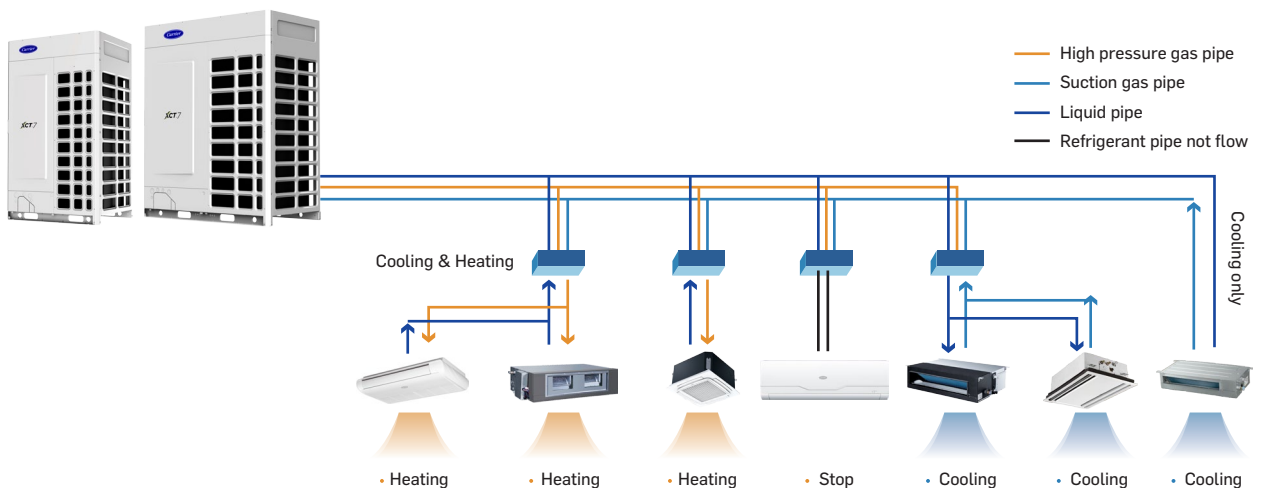
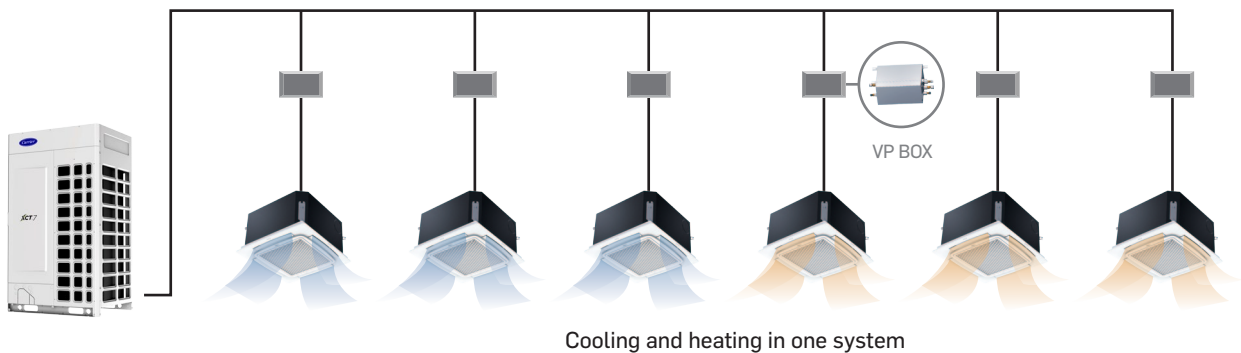

Outdoor





## Specifications

Model			38VT008173RQEE	38VT010173RQEE	38VT012173RQEE	38VT014173RQEE
Capacity		HP	8	10	12	14
Capacity <sup>(1)</sup>	Cooling	kW	22,4	28,0	33,5	40,0
	Heating	kW	22,4	28,0	33,5	40,0
Cooling Efficiency <sup>(1)</sup>	EER	W/W	3,98	3,65	3,50	3,25
	SEER	/	7,05	6,68	6,58	6,37
	ηs	%	279	264	260	252
Heating Efficiency <sup>(1)</sup>	COP	W/W	4,35	4,20	4,00	3,80
	SCOP <sup>(1)</sup>	/	4,02	3,94	4,08	3,86
	ηs	%	158	155	160	151
Electrical Parameters	Power supply	Ph/V/Hz	3/380-415/50/60	3/380-415/50/60	3/380-415/50/60	3/380-415/50/60
	Rated power input (Cooling)	kW	5,63	7,67	9,57	12,31
	Rated power input (Heating)	kW	5,15	6,67	8,38	10,53
Dimensions (H/W/D)	External	mm	980/750/1690	980/750/1690	980/750/1690	980/750/1690
	Shipping	mm	1070/850/1858	1070/850/1858	1070/850/1858	1070/850/1858
Weight	Net/Shipping	kg	246/271	246/271	257/282	257/282
Compressor	Type	/	DC INV. SCROLL	DC INV. SCROLL	DC INV. SCROLL	DC INV. SCROLL
	Motor power	W	6500	6500	7640	7640
	Compressor quantity	/	1 INV	1 INV	1 INV	1 INV
Fan	Air flow	m <sup>3</sup> /h	12000	12000	13500	13500
Pressure Sound Level <sup>(1)</sup>	Cooling	dB(A)	57	58	60	61
	Heating	dB(A)	57	58	60	61
Power Sound Level <sup>(1)</sup>	Cooling	dB(A)	81	82	88	88
	Heating	dB(A)	81	82	88	88
Refrigerant	Type	/	R410A	R410A	R410A	R410A
	Charge	kg	10	10	10	10
Piping	Refrigerant liquid pipe (∅)	mm	9,52	9,52	12,7	12,7
	Refrigerant gas pipe (∅)	mm	19,05	22,22	25,4	25,4
	Refrigerant high gas pipe (∅)	mm	19,05	19,05	22,22	22,22
	Total pipe length	m	1000	1000	1000	1000
	Max. pipe length (Equivalent/Actual)	m	260/220	260/220	260/220	260/220
	Max drop between I.U.&O.U (ODU Below/Above)	m	110/90	110/90	110/90	110/90
	Max drop between I.U.&I.U	m	30	30	30	30
Connectivity Ratio <sup>(2)</sup>	Connectable indoor unit ratio	%	50-130	50-130	50-130	50-130
	Maximum number of indoor units	/	13	16	20	24
Operating Range	Cooling	°C	-5-50	-5-50	-5-50	-5-50
	Heating	°C	-23-21	-23-21	-23-21	-23-21



(1) All the specifications are tested under nominal condition as per Eurovent conditions (In cooling, Indoor temp is 27°C DB/19°C WB; Outdoor temp 35°C DB/24°C WB; In heating, Indoor temp is 20°C DB, Outdoor temp is 7°C DB/6°C WB)

CARRIER SCS participates in the ECP program for Comfort Air Conditioner (AC).

Check ongoing validity of certificate [www.eurovent-certification.com](http://www.eurovent-certification.com)

(2) The indoor and outdoor capacity ratio should be limited within 100% when all the indoor units are in operation to ensure the system cooling/heating performance.

## Top Discharge Heat Recovery 8-22 HP



Model			38VT016173RQEE	38VT018173RQEE	38VT020173RQEE	38VT022173RQEE
Capacity		HP	16	18	20	22
Capacity <sup>(1)</sup>	Cooling	kW	45,0	50,0	56,0	60,0
	Heating	kW	45,0	50,0	56,0	60,0
Cooling Efficiency <sup>(1)</sup>	EER	W/W	3,20	3,10	3,25	3,00
	SEER	/	6,86	6,48	5,90	5,74
	ηs	%	271	256	233	227
Heating Efficiency <sup>(1)</sup>	COP	W/W	3,95	3,65	3,55	3,35
	SCOP <sup>(1)</sup>	/	4,21	3,99	3,93	3,76
	ηs	%	165	157	154	147
Electrical Parameters	Power supply	Ph/V/Hz	3/380-415/50/60	3/380-415/50/60	3/380-415/50/60	3/380-415/50/60
	Rated power input (Cooling)	kW	14,06	16,13	17,23	20,00
	Rated power input (Heating)	kW	11,39	13,70	15,78	17,91
Dimensions (H/W/D)	External	mm	1410/750/1690	1410/750/1690	1410/750/1690	1410/750/1690
	Shipping	mm	1485/850/1858	1485/850/1858	1485/850/1858	1485/850/1858
Weight	Net/Shipping	kg	366/395	366/395	375/404	375/404
Compressor	Type	/	DC INV. SCROLL	DC INV. SCROLL	DC INV. SCROLL	DC INV. SCROLL
	Motor power	W	5250 *2	5250 *2	7640 *2	7640 *2
	Compressor quantity	/	2 INV	2 INV	2 INV	2 INV
Fan	Air flow	m <sup>3</sup> /h	17000	17000	19000	19000
Pressure Sound Level <sup>(1)</sup>	Cooling	dB(A)	62	63	63	64
	Heating	dB(A)	62	63	63	64
Power Sound Level <sup>(1)</sup>	Cooling	dB(A)	88	88	88	90
	Heating	dB(A)	88	88	88	90
Refrigerant	Type	/	R410A	R410A	R410A	R410A
	Charge	kg	10	10	10	10
Piping	Refrigerant liquid pipe (∅)	mm	12,7	15,88	15,88	15,88
	Refrigerant gas pipe (∅)	mm	28,58	28,58	28,58	28,58
	Refrigerant high gas pipe (∅)	mm	25,4	25,4	25,4	25,4
	Total pipe length	m	1000	1000	1000	1000
	Max. pipe length (Equivalent/Actual)	m	260/220	260/220	260/220	260/220
	Max drop between I.U.&O.U (ODU Below/Above)	m	110/90	110/90	110/90	110/90
	Max drop between I.U.&I.U	m	30	30	30	30
Connectivity Ratio <sup>(2)</sup>	Connectable indoor unit ratio	%	50-130	50-130	50-130	50-130
	Maximum number of indoor units	/	27	30	33	36
Operating Range	Cooling	°C	-5-50	-5-50	-5-50	-5-50
	Heating	°C	-23-21	-23-21	-23-21	-23-21



(1) All the specifications are tested under nominal condition as per Eurovent conditions (In cooling, Indoor temp is 27°C DB/19°C WB; Outdoor temp 35°C DB/24°C WB; In heating, Indoor temp is 20°C DB, Outdoor temp is 7°C DB/6°C WB)  
 CARRIER SCS participates in the ECP program for Comfort Air Conditioner (AC).  
 Check ongoing validity of certificate [www.eurovent-certification.com](http://www.eurovent-certification.com)

(2) The indoor and outdoor capacity ratio should be limited within 100% when all the indoor units are in operation to ensure the system cooling/heating performance.



Turn to the experts

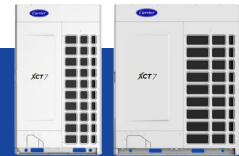

## Specifications

Model			2 Modules					
Model Code			38VT024S73RQEE	38VT026S73RQEE	38VT028S73RQEE	38VT030S73RQEE	38VT032S73RQEE	38VT034S73RQEE
Capacity	HP		24	26	28	30	32	34
Combination			12+12	12+14	14+14	14+16	16+16	16+18
Combination Model Codes			38VT012173RQEE	38VT012173RQEE	38VT014173RQEE	38VT014173RQEE	38VT016173RQEE	38VT016173RQEE
			38VT012173RQEE	38VT014173RQEE	38VT014173RQEE	38VT016173RQEE	38VT016173RQEE	38VT018173RQEE
Capacity	Cooling	kW	67,0	73,5	80,0	85,0	90,0	95,0
	Heating	kW	67,0	73,5	80,0	85,0	90,0	95,0
Cooling Efficiency	EER	W/W	3,50	3,36	3,25	3,22	3,20	3,15
	SEER		6,58	6,46	6,37	6,61	6,86	6,64
Heating Efficiency	COP	W/W	4,00	3,89	3,80	3,88	3,95	3,79
	SCOP	/	4,08	3,94	3,86	4,02	4,21	4,08
Maximum Number of Indoor Units	/		40	43	47	50	53	56

Model			3 Modules					
Model Code			38VT046S73RQEE	38VT048S73RQEE	38VT050S73RQEE	38VT052S73RQEE	38VT054S73RQEE	38VT056S73RQEE
Capacity	HP		46	48	50	52	54	56
Combination			14+16+16	16+16+16	16+16+18	16+18+18	18+18+18	18+18+20
Combination Model Codes			38VT014173RQEE	38VT016173RQEE	38VT016173RQEE	38VT016173RQEE	38VT018173RQEE	38VT018173RQEE
			38VT016173RQEE	38VT016173RQEE	38VT016173RQEE	38VT018173RQEE	38VT018173RQEE	38VT018173RQEE
			38VT016173RQEE	38VT016173RQEE	38VT018173RQEE	38VT018173RQEE	38VT018173RQEE	38VT020173RQEE
Capacity	Cooling	kW	130,0	135,0	140,0	145,0	150,0	156,0
	Heating	kW	130,0	135,0	140,0	145,0	150,0	156,0
Cooling Efficiency	EER	W/W	3,22	3,20	3,16	3,13	3,10	3,15
	SEER		6,70	6,86	6,70	6,58	6,48	6,25
Heating Efficiency	COP	W/W	3,90	3,95	3,84	3,74	3,65	3,61
	SCOP	/	4,08	4,21	4,12	4,05	3,99	3,97
Maximum Number of Indoor Units	/		64	64	64	64	64	64

Model			4 Modules					
Model Code			38VT068S73RQEE	38VT070S73RQEE	38VT072S73RQEE	38VT074S73RQEE	38VT076S73RQEE	38VT078S73RQEE
Capacity	HP		68	70	72	74	76	78
Combination			16+16+18+18	16+18+18+18	18+18+18+18	18+18+18+20	18+18+20+20	18+20+20+20
Combination Model Codes			38VT016173RQEE	38VT016173RQEE	38VT018173RQEE	38VT018173RQEE	38VT018173RQEE	38VT018173RQEE
			38VT016173RQEE	38VT018173RQEE	38VT018173RQEE	38VT018173RQEE	38VT018173RQEE	38VT020173RQEE
			38VT018173RQEE	38VT018173RQEE	38VT018173RQEE	38VT018173RQEE	38VT020173RQEE	38VT020173RQEE
			38VT018173RQEE	38VT018173RQEE	38VT018173RQEE	38VT020173RQEE	38VT020173RQEE	38VT020173RQEE
Capacity	Cooling	kW	190,0	195,0	200,0	206,0	212,0	218,0
	Heating	kW	190,0	195,0	200,0	206,0	212,0	218,0
Cooling Efficiency	EER	W/W	3,15	3,12	3,10	3,14	3,18	3,21
	SEER		6,64	6,55	6,48	6,30	6,15	6,02
Heating Efficiency	COP	W/W	3,79	3,72	3,65	3,62	3,60	3,57
	SCOP	/	4,08	4,04	3,99	3,98	3,96	3,94
Maximum Number of Indoor Units	/		64	64	64	64	64	64

## Top Discharge Heat Recovery 24-88 HP



Model			2 Modules				
Model Code			38VT036S73RQEE	38VT038S73RQEE	38VT040S73RQEE	38VT042S73RQEE	38VT044S73RQEE
Capacity	HP		36	38	40	42	44
Combination			18+18	18+20	20+20	20+22	22+22
Combination Model Codes			38VT018173RQEE	38VT018173RQEE	38VT020173RQEE	38VT020173RQEE	38VT022173RQEE
			38VT018173RQEE	38VT020173RQEE	38VT020173RQEE	38VT022173RQEE	38VT022173RQEE
Capacity	Cooling	kW	100,0	106,0	112,0	116,0	120,0
	Heating	kW	100,0	106,0	112,0	116,0	120,0
Cooling Efficiency	EER	W/W	3,10	3,18	3,25	3,12	3,00
	SEER		6,48	6,15	5,90	5,81	5,74
Heating Efficiency	COP	W/W	3,65	3,60	3,55	3,44	3,35
	SCOP	/	3,99	3,96	3,93	3,83	3,76
Maximum Number of Indoor Units	/		59	63	64	64	64

Model			3 Modules				
Model Code			38VT058S73RQEE	38VT060S73RQEE	38VT062S73RQEE	38VT064S73RQEE	38VT066S73RQEE
Capacity	HP		58	60	62	64	66
Combination			18+20+20	20+20+20	20+20+22	20+22+22	22+22+22
Combination Model Codes			38VT018173RQEE	38VT020173RQEE	38VT020173RQEE	38VT020173RQEE	38VT022173RQEE
			38VT020173RQEE	38VT020173RQEE	38VT020173RQEE	38VT022173RQEE	38VT022173RQEE
			38VT020173RQEE	38VT020173RQEE	38VT022173RQEE	38VT022173RQEE	38VT022173RQEE
Capacity	Cooling	kW	162,0	168,0	172,0	176,0	180,0
	Heating	kW	162,0	168,0	172,0	176,0	180,0
Cooling Efficiency	EER	W/W	3,20	3,25	3,16	3,08	3,00
	SEER		6,06	5,90	5,84	5,79	5,74
Heating Efficiency	COP	W/W	3,58	3,55	3,48	3,41	3,35
	SCOP	/	3,95	3,93	3,86	3,81	3,76
Maximum Number of Indoor Units	/		64	64	64	64	64

Model			4 Modules				
Model Code			38VT080S73RQEE	38VT082S73RQEE	38VT084S73RQEE	38VT086S73RQEE	38VT088S73RQEE
Capacity	HP		80	82	84	86	88
Combination			20+20+20+20	20+20+20+22	20+20+22+22	20+22+22+22	22+22+22+22
Combination Model Codes			38VT020173RQEE	38VT020173RQEE	38VT020173RQEE	38VT020173RQEE	38VT022173RQEE
			38VT020173RQEE	38VT020173RQEE	38VT020173RQEE	38VT022173RQEE	38VT022173RQEE
			38VT020173RQEE	38VT020173RQEE	38VT022173RQEE	38VT022173RQEE	38VT022173RQEE
			38VT020173RQEE	38VT022173RQEE	38VT022173RQEE	38VT022173RQEE	38VT022173RQEE
Capacity	Cooling	kW	224,0	228,0	232,0	236,0	240,0
	Heating	kW	224,0	228,0	232,0	236,0	240,0
Cooling Efficiency	EER	W/W	3,25	3,18	3,12	3,06	3,00
	SEER		5,90	5,86	5,81	5,77	5,74
Heating Efficiency	COP	W/W	3,55	3,50	3,44	3,40	3,35
	SCOP	/	3,93	3,88	3,83	3,79	3,76
Maximum Number of Indoor Units	/		64	64	64	64	64





Turn to the experts

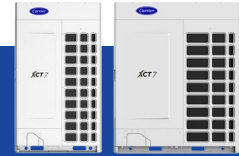

**Dimensions (for all Top Discharge units)**

Single Fan Heat Pump (8-16HP)  
Single Fan Heat Recovery (8-14HP)

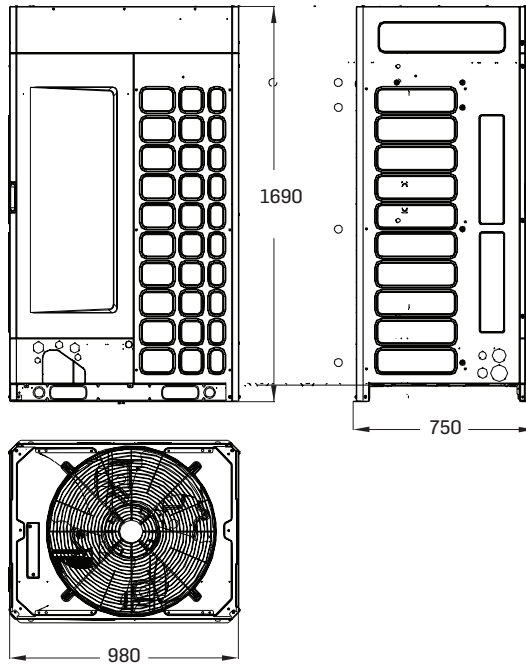

Dual Fan Heat Pump (18-26HP)  
Dual Fan Heat Recovery (16-22HP)

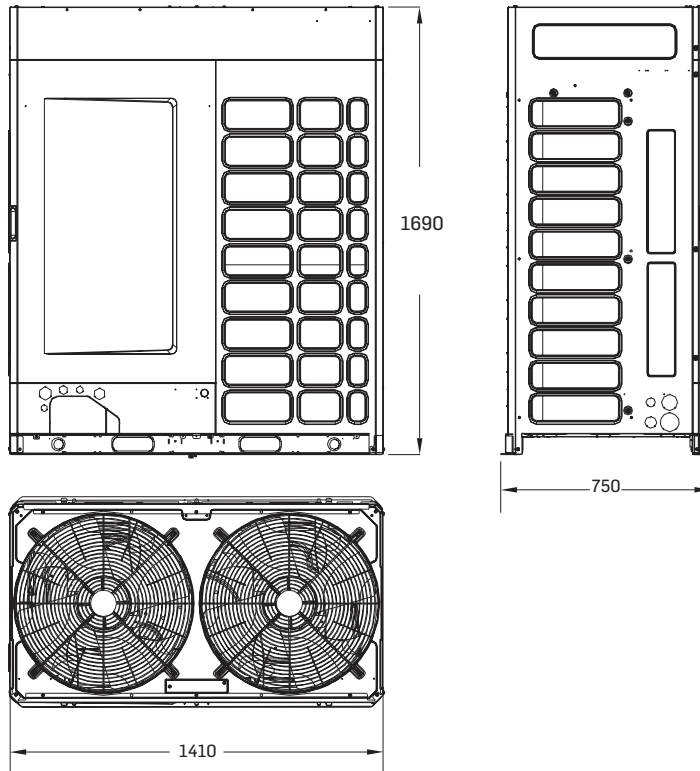

Outdoor



### Combination Installation Dimensions

- There should be no obstacles within 2000 mm above the outdoor unit.  
Obstacles around the outdoor unit should be less than 900 mm to the bottom of unit.
- When multiple modules are installed, the outdoor unit should be ranked according to capacity, with the larger capacity closer to the main pipe.

#### Single Installation

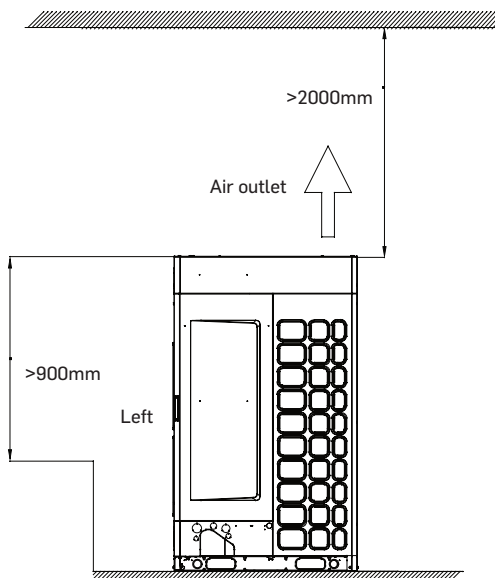

#### Combination Installation

Unit can be installed facing the same or opposite direction

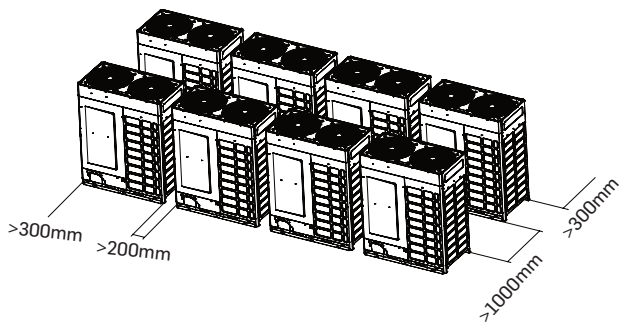

### Wall Higher Than The Outdoor Condensers

Place with air inlet hole

#### Notes:

- Fan speed  $V_s$  at air inlet is 1.5 m/s or below.
- Air outlet height  $HD = H - h$  and below 1 m.

#### Single Fan Top Discharge

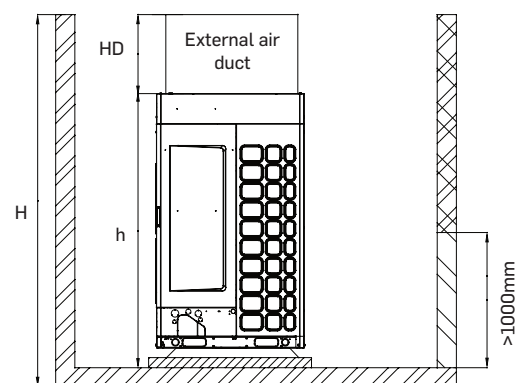
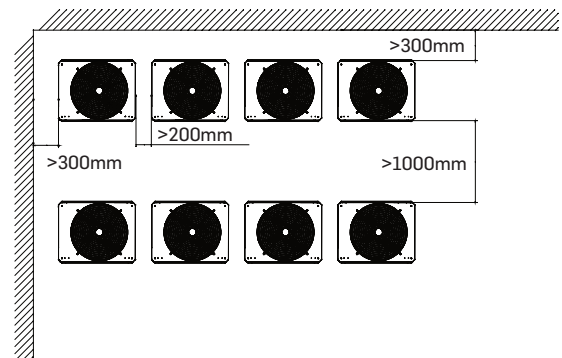
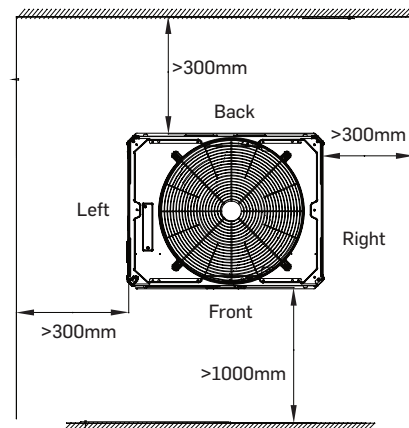



Turn to the experts



OFFICES



HOTELS



RETAIL



ADMINISTRATIONS



OFFICES





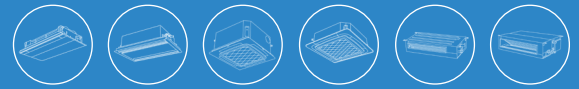

## INDOOR UNITS

067	ONE-WAY CASSETTE	099	HIGH WALL
071	TWO-WAY CASSETTE	103	TWO-WAY CONSOLE
075	COMPACT FOUR-WAY CASSETTE	107	CONSOLE-RECESSED
079	ROUND-WAY CASSETTE	109	FLEX CEILING FLOOR (AC MOTOR)
085	SLIM DUCT	111	FLEX CEILING FLOOR (DC MOTOR)
089	STANDARD STATIC DUCT (20/200PA)	117	HRV
093	HIGH STATIC DUCT(0/200PA)		





### Benefits Glance Over

		CASSETTE				DUCT	
Features		ONE-WAY CASSETTE 	TWO-WAY CASSETTE 	COMPACT FOUR-WAY CASSETTE 	ROUND-WAY CASSETTE 	SLIM DUCT 	STANDARD STATIC DUCT (20-200PA) 
		40VU*1-7E	40VU*2-7G	40VU*C-7S	40VU*R-7E	40VD*L-7E	40VD*S-7S
Comfortable	Washable filter included: • Ensures clean air • Extends the life of the fan	●	●	●	●	●	●
	Independent control of the air flow directions: • Flexible control for different needs • Ensures comfortable environment				●		
	Multi-gear air speed selection: • Meet different requirements of installation & usage	●	●	●	●	●	●
	Presence sensor (optional): • Automatically switches on & off when people come in & out • Energy conservation				● (Optional)		
	• Brushless DC motor: • Operation noise reduced	●		●	●	●	●
Aesthetic	• Streamlined design • Easily fits in with different interior designs	●	●		●		
	• Ultra-thin & compact design • Save ceiling space	●	●	●	●	●	●
Convenient	• Optional location of air return (front air return & back air return) • Friendly Installation					●	●
	Easy disassembly of the maintenance panel	●	●		●		
	• Adjustable static pressure • Flexible selection according to the actual installation					●	●
	• Standard drain pump • Drain water discharged easily	●	●	●	●	●	●
	Reserved fresh air inlet			●	●		●
Intelligent	Centralized control compatible	●	●	●	●	●	●
	Room card	●	●	●	●	●	●
	Cleaning reminder of the washable filter	●	●	●	●	●	●



		DUCT	WALL MOUNTED UNIT	FLOOR STANDING UNITS		CEILING FLOOR		VENTILATION
Features		HIGH STATIC DUCT (0/200 PA) 	HIGH WALL 	TWO-WAY CONSOLE 	CONSOLE - RECESSED 	FLEX CEILING FLOOR AC FAN 	FLEX CEILING FLOOR DC FAN 	HRV 
		40VD*H-7S	40VK*S-7S	40VL*B-7E	40VL*R-7G	40VC*F-7G	40VC*F-7S	40VH*A-7G
Comfortable	Washable filter included: • Ensures clean air • Extends the life of the fan	●	●	●	●	●	●	●
	Independent control of the air flow directions: • Flexible control for different needs • Ensures comfortable environment		●			●	●	
	Multi-gear air speed selection: • Meet different requirements of installation & usage	●	●	●	●	●	●	●
	Presence sensor (optional): • Automatically switches on & off when people come in & out • Energy conservation							
	• Brushless DC motor: • Operation noise reduced	●	●	●			●	
Aesthetic	• Streamlined design • Easily fits in with different interior designs		●	●		●	●	
	• Ultra-thin & compact design • Save ceiling space	●						
Convenient	• Optional location of air return (front air return & back air return) • Friendly Installation							
	Easy disassembly of the maintenance panel			●		●	●	
	• Adjustable static pressure • Flexible selection according to the actual installation	●						
	• Standard drain pump • Drain water discharged easily	●						
	Reserved fresh air inlet	●				●	●	
Intelligent	Centralized control compatible	●	●	●	●	●	●	●
	Room card	●	●	●	●	●	●	
	Cleaning reminder of the washable filter	●	●	●	●	●	●	



Turn to the experts



Indoor





Indoor









Turn to the experts



Indoor

## ONE-WAY CASSETTE (DC MOTOR) 40VU\*1-7E

-  Slim & elegant design only 185mm height
-  DC powered fan with industry-leading noise levels down to 25dB(A)
-  Return air panel serves as a service port to maintain the unit
-  Built-in drain pump
-  Unique ceiling anti-fouling design



Optional Panel: 40VPU01217EQEE



Wired Controller  
40VCW217FQEE



Simple Wired Controller  
40VCW117FQEE



Wired Weekly Timer  
40VCW317FQEE



Wireless Controller  
40VCI57FQEE



## Specifications



COOLING



HEATING

Model Code	Item	Unit	40VU0051-7E-QEE	40VU0071-7E-QEE	40VU0091-7E-QEE	40VU0121-7E-QEE
Capacity	Model capacity	HP	0,5	0,8	1,0	1,25
	Cooling	kW	1,5	2,2	2,8	3,6
	Heating	kW	1,7	2,5	3,2	4,0
Electrical Parameters	Power supply	Ph/V/Hz	1/220-230/50/60	1/220-230/50/60	1/220-230/50/60	1/220-230/50/60
	Power consumption	W	21	21	21	23
Dimensions (W/D/H)	Net Product	mm	875/505/185	875/505/185	875/505/185	875/505/185
	Shipping Product	mm	1028/581/270	1028/581/270	1028/581/270	1028/581/270
	Net Panel	mm	1050/560/122	1050/560/122	1050/560/122	1050/560/122
	Shipping Panel	mm	1133/623/197	1133/623/197	1133/623/197	1133/623/197
Weight	Product Net/Shipping	kg	15.3/17.9	15.3/17.9	15.3/17.9	15.3/17.9
	Panel Net/Shipping	kg	5.3/8.3	5.3/8.3	5.3/8.3	5.3/8.3
Fan	Air flow (H/M/L)	m <sup>3</sup> /h	530/490/450	530/490/450	530/490/450	550/530/490
Pressure sound level	Cooling (H/M/L)	dB(A)	32/29/24	32/29/24	32/29/24	34/30/25
	Heating (H/M/L)	dB(A)	32/29/24	32/29/24	32/29/24	34/30/25
Piping	Refrigerant liquid pipe (Ø)	mm	6,35	6,35	6,35	6,35
	Refrigerant gas pipe (Ø)	mm	9,52	9,52	9,52	12,7
	Drain port diameter	mm	24	24	24	24
Drain pump	O-optional, S-standard, N-not incl.	/	S	S	S	S
Accessories (Optional)	Panel Model Code	/	40VPU01217EQEE	40VPU01217EQEE	40VPU01217EQEE	40VPU01217EQEE

Indoor

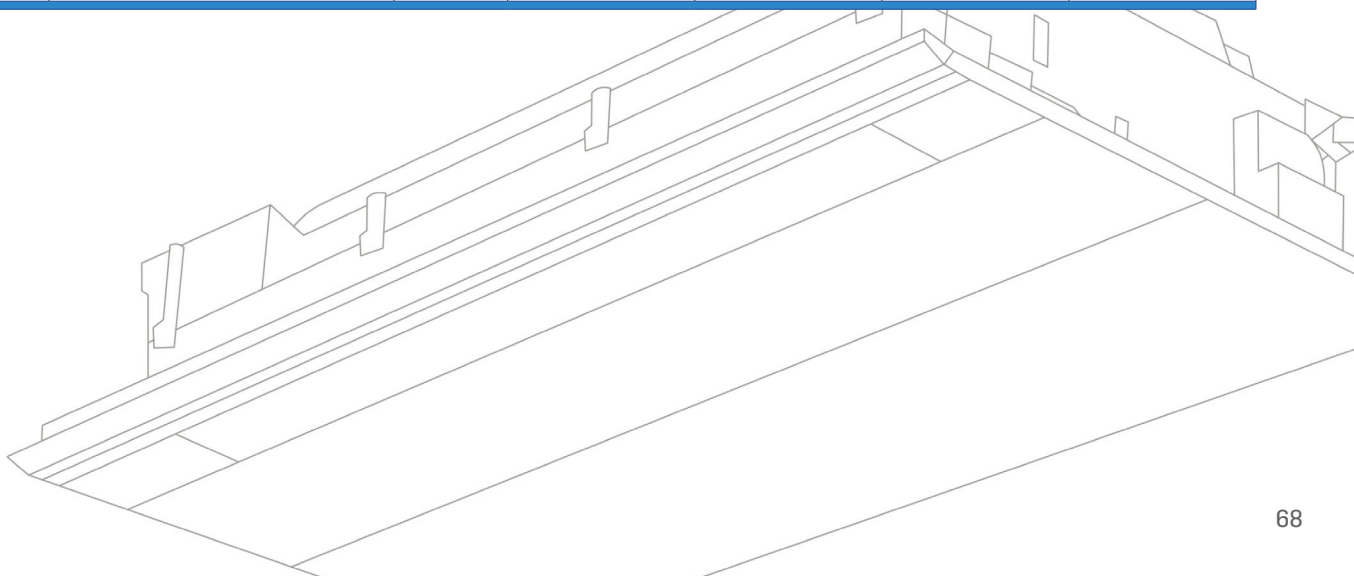



## ONE-WAY CASSETTE (DC MOTOR)



Indoor

### Easy Service & Maintenance

- Easy removal of air filters for cleaning
- Easy access to indoor unit components

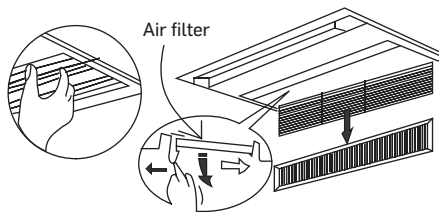

### Standard Built-in Drain Pump

Standard built-in drain pump with 1200 mm pumphead and slim body makes the installation free from limitation of story height.

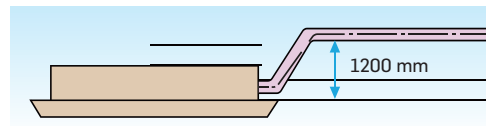

### Height 185 mm Only

Compact design, slim body with a min. height of 185 mm only, especially suitable for spaces with a narrow ceiling, such as lobbies, small-size meeting room, mansions, restaurant, etc.

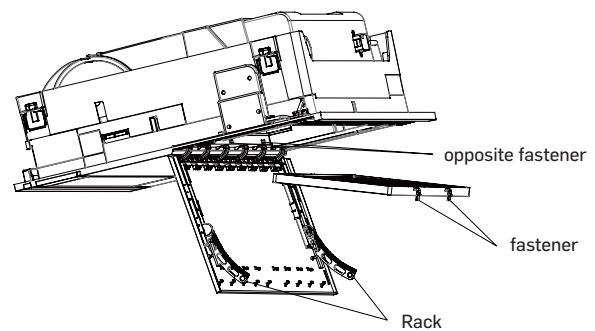
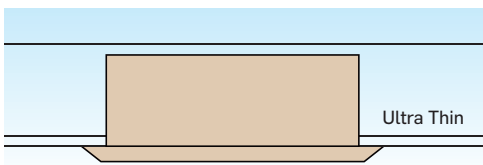



## Dimensions

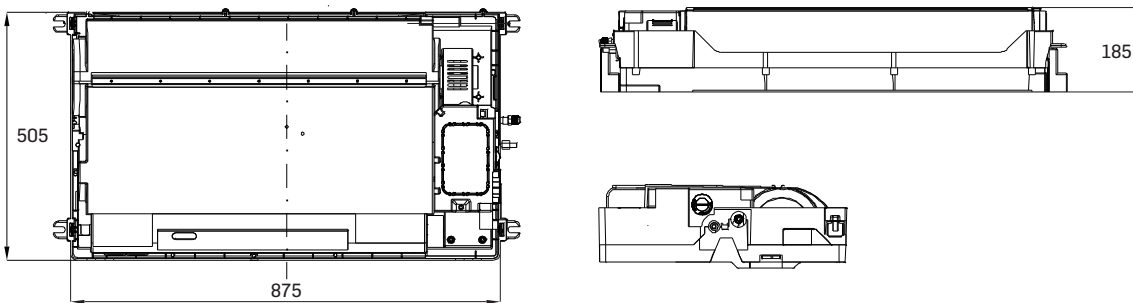

## Installation & Service

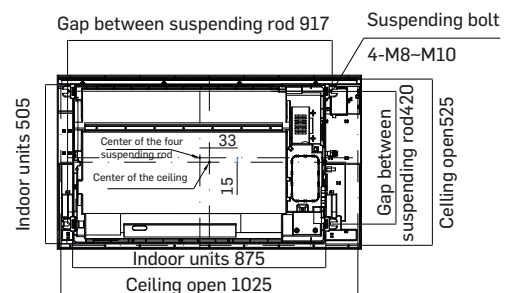
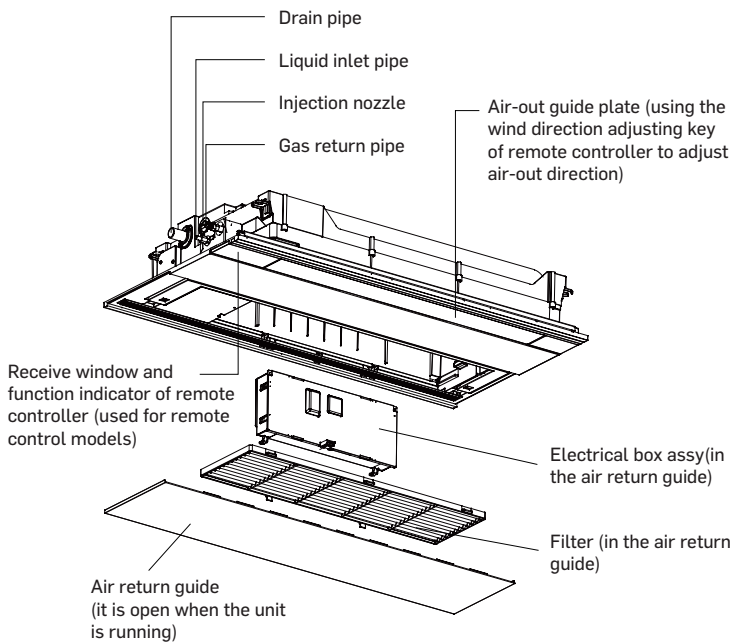

### Installation space

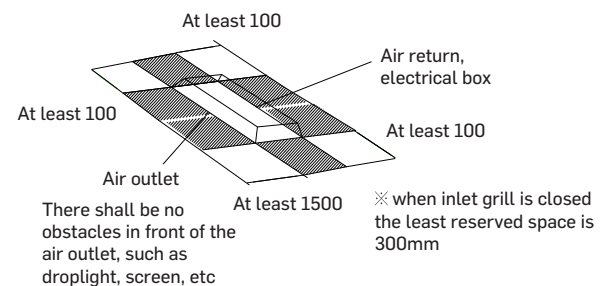









Turn to the experts



Indoor

## TWO-WAY CASSETTE (AC MOTOR) 40VU\*2-7G

-  Compact design: only 220 mm in height
-  Built-in drain pump
-  Unique ceiling anti-fouling design
-  Dual air supply to distribute air in two directions with quiet operation



Optional Panel: 40VPU01827GQEE

- |   |   |   |   |
|---|---|---|---|
|  |  |  |  |
| Wired Controller<br>40VCW217FQEE  | Simple Wired<br>Controller<br>40VCW117FQEE  | Wired Weekly<br>Timer<br>40VCW317FQEE   | Wireless Controller<br>40VCI57FQEE  |



## Specifications



COOLING



HEATING

Model Code	Item	Unit	40VU0072-7G-QEE	40VU0092-7G-QEE	40VU0122-7G-QEE	40VU0162-7G-QEE	40VU0182-7G-QEE
Capacity	Model capacity	HP	0,8	1,0	1,25	1,7	2,0
	Cooling	kW	2,2	2,8	3,6	4,5	5,6
	Heating	kW	2,5	3,2	4,0	5,0	6,3
Electrical Parameters	Power supply	Ph/V/Hz	1/220-230/50/60	1/220-230/50/60	1/220-230/50/60	1/220-230/50/60	1/220-230/50/60
	Power consumption	W	90	90	90	110	110
Dimensions (W/D/H)	Net Product	mm	817/620/220	817/620/220	817/620/220	817/620/220	817/620/220
	Shipping Product	mm	1015/695/260	1015/695/260	1015/695/260	1015/695/260	1015/695/260
	Net Panel	mm	1055/680/68	1055/680/68	1055/680/68	1055/680/68	1055/680/68
	Shipping Panel	mm	1110/720/160	1110/720/160	1110/720/160	1110/720/160	1110/720/160
Weight	Product Net/Shipping	kg	21/23	21/23	21/23	21/23	21/23
	Panel Net/Shipping	kg	7/8	7/8	7/8	7/8	7/8
Fan	Air flow (H/M/L)	m <sup>3</sup> /h	840/700/550	840/700/550	840/700/550	840/700/550	840/700/550
Pressure sound level	Cooling (H/M/L)	dB(A)	42/37/33	42/37/33	42/37/33	44/39/34	44/39/34
	Heating (H/M/L)	dB(A)	42/37/33	42/37/33	42/37/33	44/39/34	44/39/34
Piping	Refrigerant liquid pipe (Ø)	mm	6,35	6,35	6,35	6,35	6,35
	Refrigerant gas pipe (Ø)	mm	9,52	9,52	12,7	12,7	12,7
	Drain port diameter	mm	32	32	32	32	32
Drain pump	O-optional, S-standard, N-not incl.	/	S	S	S	S	S
Accessories (Optional)	Panel Model Code	/	40VPU01827GQEE	40VPU01827GQEE	40VPU01827GQEE	40VPU01827GQEE	40VPU01827GQEE

Indoor

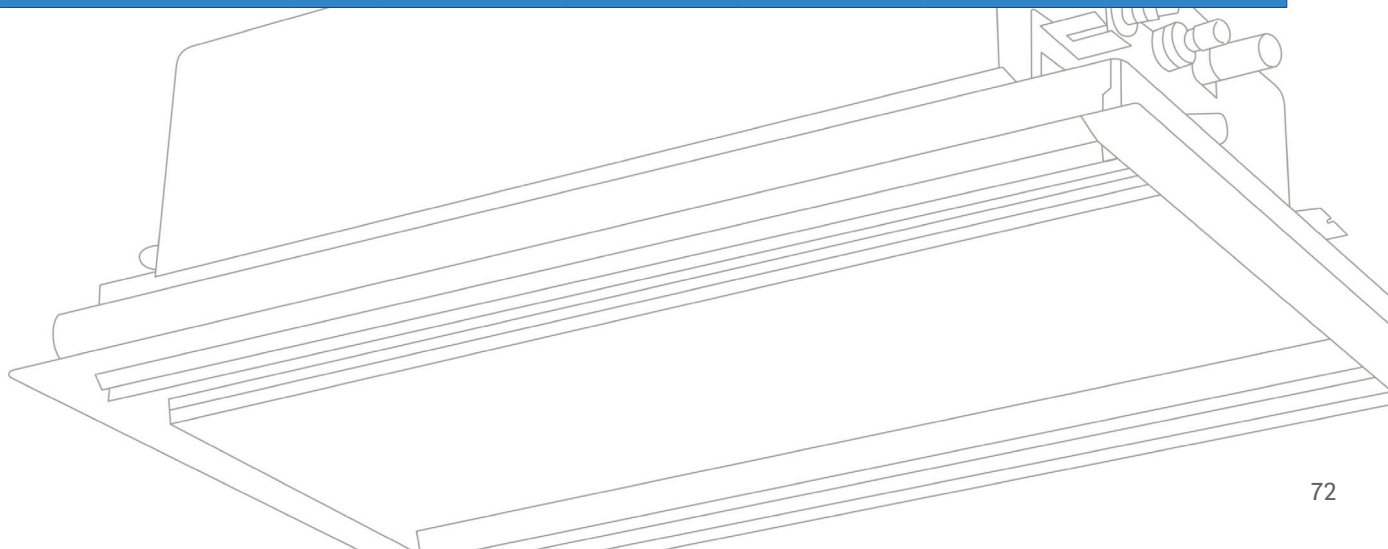



Turn to the experts



## TWO-WAY CASSETTE (AC MOTOR)



Indoor

### Stylish Design & Slim Body

Thanks to the stylish appearance and slim body, the unit can be harmonious with the room decoration. The sleek body, just 220 mm in height, needs only a small ceiling space to be suspended. Installation is free of story height limitations which makes design and decoration much more flexible.

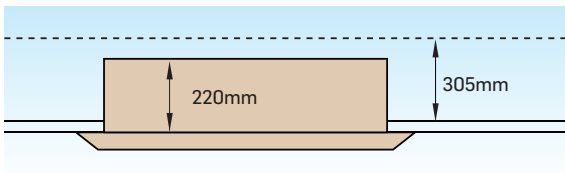

### Standard Built-in Drain Pump

Standard built-in drain pump with 700 mm pump head. Flat-type suction grille design makes maintenance work very easy.

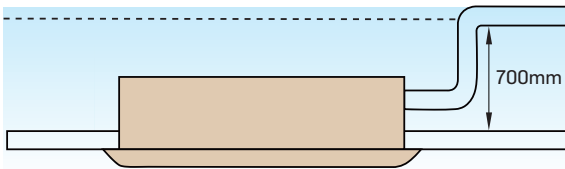



## Dimensions

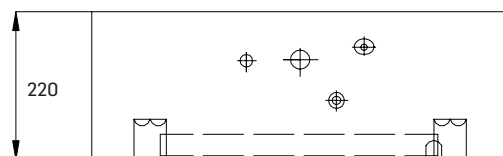
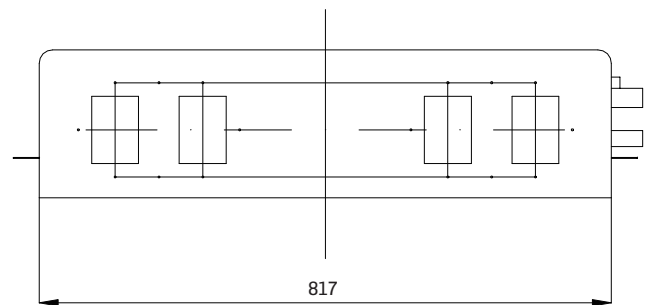
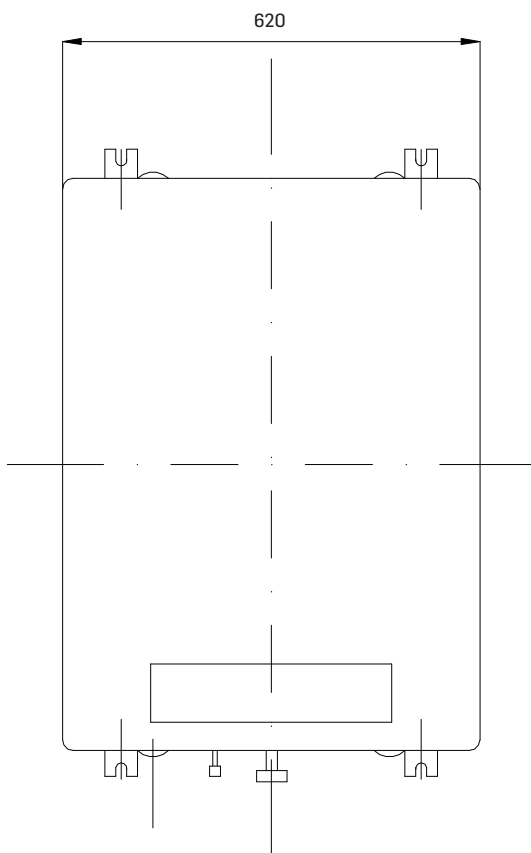

Indoor





Turn to the experts



Indoor

## COMPACT FOUR-WAY CASSETTE (DC MOTOR) 40VU\*C-7S

- Compact design: installation restrictions reduced to enable high flexibility  
Ideal for standard ceiling tiles and small rooms: 570\*570 mm body size and 620\*620 mm panel size
- Built-in drain pump
- Low sound level, high efficiency and comfort
- Knockout hole for outside air



Optional Panel: 40VPU018C7SQEE



Wired Controller  
40VCW217FQEE



Simple Wired Controller  
40VCW117FQEE



Wired Weekly Timer  
40VCW317FQEE



Wireless Controller  
40VCI57FQEE

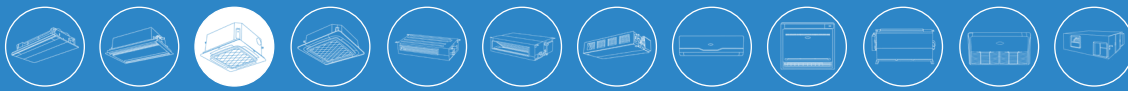

## Specifications



COOLING



HEATING

Model Code	Item	Unit	40VU005C-7S-QEE	40VU007C-7S-QEE	40VU009C-7S-QEE	40VU012C-7S-QEE	40VU016C-7S-QEE	40VU018C-7S-QEE
Capacity	Model capacity	HP	0,5	0,8	1,0	1,25	1,7	2,0
	Cooling	kW	1,5	2,2	2,8	3,6	4,5	5,6
	Heating	kW	1,7	2,5	3,2	4,0	5,0	6,3
Electrical Parameters	Power supply	Ph/V/Hz	1/220-240/50/60	1/220-240/50/60	1/220-240/50/60	1/220-240/50/60	1/220-240/50/60	1/220-240/50/60
	Power consumption	W	17	17	17	18	26	35
Dimensions (W/D/H)	Net Product	mm	570/570/260	570/570/260	570/570/260	570/570/260	570/570/260	570/570/260
	Shipping Product	mm	718/680/380	718/680/380	718/680/380	718/680/380	718/680/380	718/680/380
	Net Panel	mm	620/620/60	620/620/60	620/620/60	620/620/60	620/620/60	620/620/60
	Shipping Panel	mm	660/660/115	660/660/115	660/660/115	660/660/115	660/660/115	660/660/115
Weight	Product Net/Shipping	kg	16/19	16/19	16/19	19/22	19/22	19/22
	Panel Net/Shipping	kg	2.8/4.5	2.8/4.5	2.8/4.5	2.8/4.5	2.8/4.5	2.8/4.5
Fan	Air flow (H/M/L)	m <sup>3</sup> /h	520/450/400	520/450/400	520/450/400	520/450/400	650/520/450	760/650/520
Pressure sound level	Cooling (H/M/L)	dB(A)	32/30/29	32/30/29	32/30/29	33/30/29	33/30/29	34/32/30
	Heating (H/M/L)	dB(A)	32/30/29	32/30/29	32/30/29	33/30/29	33/30/29	34/32/30
Piping	Refrigerant liquid pipe (Ø)	mm	6,35	6,35	6,35	6,35	6,35	6,35
	Refrigerant gas pipe (Ø)	mm	9,52	9,52	9,52	12,7	12,7	12,7
	Drain port diameter	mm	32	32	32	32	32	32
Drain pump	O-optional, S-standard, N-not incl.	/	S	S	S	S	S	S
Accessories (Optional)	Panel Model Code	/	40VPU018C7SQEE	40VPU018C7SQEE	40VPU018C7SQEE	40VPU018C7SQEE	40VPU018C7SQEE	40VPU018C7SQEE

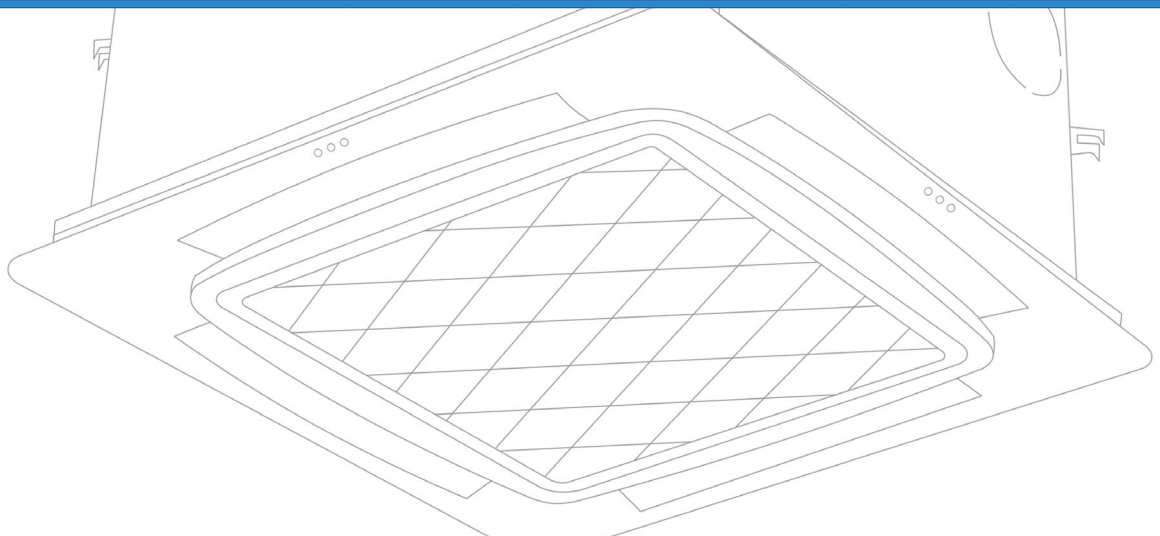

Indoor



## COMPACT FOUR-WAY CASSETTE (DC MOTOR)



Indoor

### Compact Design, Easy Installation, Service & Maintenance

Extremely compact casing (570 mm in width and 260 mm in depth) makes it match perfectly with the ambient decoration. Little space is required for installation into a shallow ceiling. Due to its compact body and light weight, all models can be installed without a hoist.

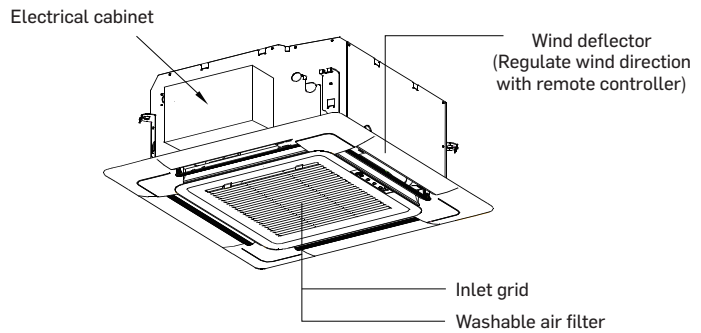
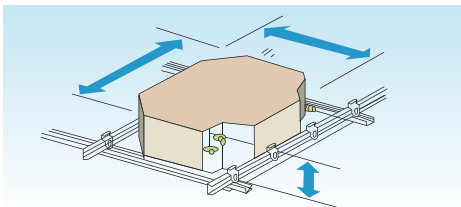

### Easy Service & Maintenance

- Easy removal of air filters for cleaning
- Easy access to indoor unit components

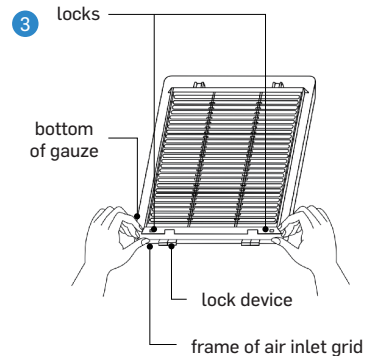
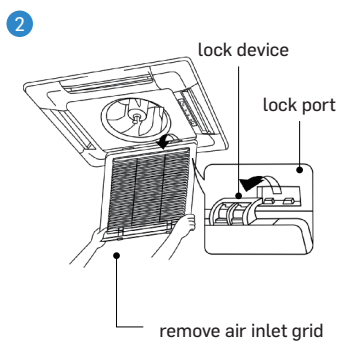
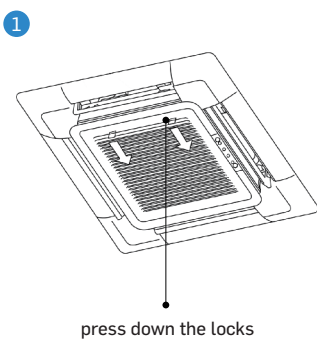



### Standard Built-in Drain Pump

Drain pump with 1200 mm pump head as the standard fitting.

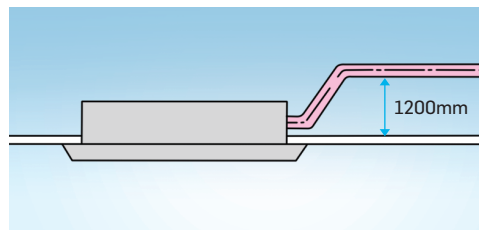

### Dimensions

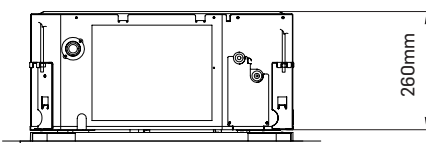
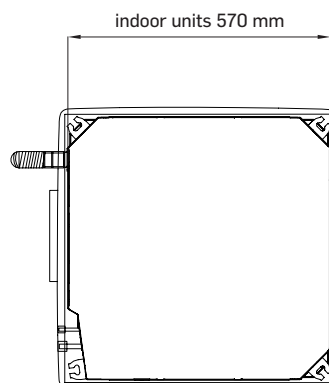
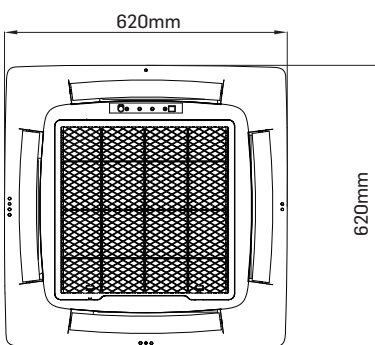

Indoor





Indoor

## Specifications

Model Code	Item	Unit	40VU007R-7E-QEE	40VU009R-7E-QEE	40VU012R-7E-QEE	40VU016R-7E-QEE	40VU018R-7E-QEE	40VU024R-7E-QEE
Capacity	Model capacity	HP	0,8	1,0	1,25	1,7	2,0	2,5
	Cooling	kW	2,2	2,8	3,6	4,5	5,6	7,1
	Heating	kW	2,5	3,2	4,0	5,0	6,3	8,0
Electrical Parameters	Power supply	Ph/V/Hz	1/220-230/50/60	1/220-230/50/60	1/220-230/50/60	1/220-230/50/60	1/220-230/50/60	1/220-230/50/60
	Power consumption	W	30	30	30	30	30	50
Dimensions (W/D/H)	Net Product	mm	840/840/183	840/840/183	840/840/183	840/840/183	840/840/183	840/840/204
	Shipping Product	mm	983/983/268	983/983/268	983/983/268	983/983/268	983/983/268	983/983/290
	Net Panel	mm	950/950/50	950/950/50	950/950/50	950/950/50	950/950/50	950/950/50
	Shipping Panel	mm	1013/1025/123	1013/1025/123	1013/1025/123	1013/1025/123	1013/1025/123	1013/1025/123
Weight	Product Net/Shipping	kg	25/28	25/28	25/28	25/28	25/28	27/30
	Panel Net/Shipping	kg	6.5/9	6.5/9	6.5/9	6.5/9	6.5/9	6.5/9
Fan	Air flow (H/M/L)	m <sup>3</sup> /h	1000/810/620	1000/810/620	1000/810/620	1000/810/620	1000/810/620	1380/1190/1000
Pressure sound level	Cooling (H/M/L)	dB(A)	30/27/25	30/27/25	30/27/25	32/29/27	33/30/29	35/34/31
	Heating (H/M/L)	dB(A)	30/27/25	30/27/25	30/27/25	32/29/27	33/30/29	35/34/31
Piping	Refrigerant liquid pipe (Ø)	mm	6,35	6,35	6,35	6,35	6,35	9,52
	Refrigerant gas pipe (Ø)	mm	9,52	9,52	12,7	12,7	12,7	15,88
	Drain port diameter	mm	25	25	25	25	25	25
Drain pump	O-optional, S-standard, N-not incl.	/	S	S	S	S	S	S
Accessories (Optional)	Panel Model Code - Standard	/	40VPU054R7EQEE	40VPU054R7EQEE	40VPU054R7EQEE	40VPU054R7EQEE	40VPU054R7EQEE	40VPU054R7EQEE
	Panel Model Code With Presence Sensor	Additional Feature	40VPU054A7EQEE	40VPU054A7EQEE	40VPU054A7EQEE	40VPU054A7EQEE	40VPU054A7EQEE	40VPU054A7EQEE

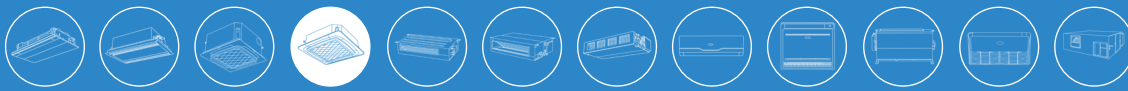

## ROUND-WAY CASSETTE (DC MOTOR) 40VU\*R-7E

- Round corner design
- Unique round-way air outlet and air distribution to reduce blind spots
- DC powered fan with low sound level and high efficiency
- Built-in drain pump
- Innovative four-way independent airflow control, 6 adjustable lower positions and 1296 air flow combinations
- Up to 4.2 m ceiling height with a large capacity
- Automatic display of fault codes



Optional Panel: 40VPU054R7EQEE

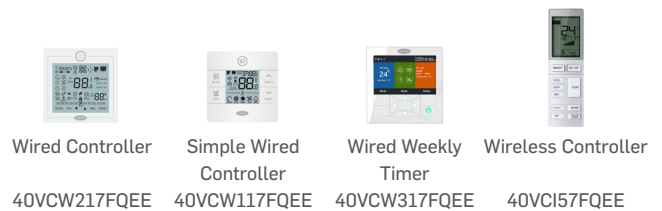

### Specifications



Model Code	Item	Unit	40VU028R-7E-QEE	40VU030R-7E-QEE	40VU038R-7E-QEE	40VU048R-7E-QEE	40VU054R-7E-QEE
Capacity	Model capacity	HP	3,0	3,2	4,0	5,0	6,0
	Cooling	kW	8,0	9,0	11,2	14,0	16,0
	Heating	kW	9,0	10,0	12,5	16,0	18,0
Electrical Parameters	Power supply	Ph/V/Hz	1/220~230/50/60	1/220~230/50/60	1/220~230/50/60	1/220~230/50/60	1/220~230/50/60
	Power consumption	W	50	90	90	110	110
Dimensions (W/D/H)	Net Product	mm	840/840/204	840/840/246	840/840/246	840/840/288	840/840/288
	Shipping Product	mm	983/983/290	983/983/331	983/983/331	983/983/373	983/983/373
	Net Panel	mm	950/950/50	950/950/50	950/950/50	950/950/50	950/950/50
	Shipping Panel	mm	1013/1025/123	1013/1025/123	1013/1025/123	1013/1025/123	1013/1025/123
Weight	Product Net/Shipping	kg	27/30	31/36	31/36	33/38	33/38
	Panel Net/Shipping	kg	6.5/9	6.5/9	6.5/9	6.5/9	6.5/9
Fan	Air flow (H/M/L)	m <sup>3</sup> /h	1380/1190/1000	2050/1860/1670	2050/1860/1670	2100/1910/1720	2100/1910/1720
Pressure sound level	Cooling (H/M/L)	dB(A)	37/35/31	37/35/31	37/35/31	44/40/36	44/40/36
	Heating (H/M/L)	dB(A)	37/35/31	37/35/31	37/35/31	44/40/36	44/40/36
Piping	Refrigerant liquid pipe (Ø)	mm	9,52	9,52	9,52	9,52	9,52
	Refrigerant gas pipe (Ø)	mm	15,88	15,88	15,88	15,88	15,88
	Drain port diameter	mm	25	25	25	25	25
Drain pump	O-optional, S-standard, N-not incl.	/	S	S	S	S	S
Accessories (Optional)	Panel Model Code - Standard	/	40VPU054R7EQEE	40VPU054R7EQEE	40VPU054R7EQEE	40VPU054R7EQEE	40VPU054R7EQEE
	Panel Model Code With Presence Sensor	Additional Feature	40VPU054A7EQEE	40VPU054A7EQEE	40VPU054A7EQEE	40VPU054A7EQEE	40VPU054A7EQEE



## ROUND-WAY CASSETTE (DC MOTOR)



Indoor

### Standard Duilt-in Drain Pump

Standard built-in drain pump can take the condensed water up to 1200 mm which makes easier installation of the drain piping system.

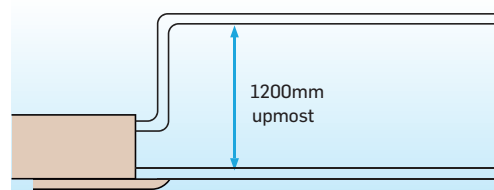

### Smart Self Diagnostic Function

By adding digital tube displayer on the display board, the error codes can be displayed directly for trouble shooting.



### Save Energy

Optional panel with presence sensor

- In case of detected human, IDU turns on
- Without movement, IDU goes in off mode



### Easy Service & Maintenance

- Easy removal of air filter for cleaning
- Remote on/off function and alarm function
- Easy access to indoor unit components

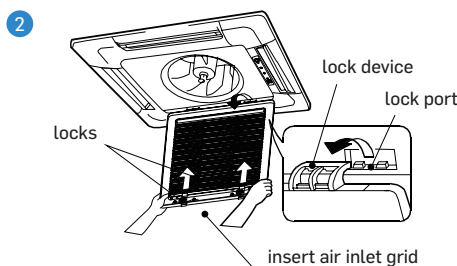
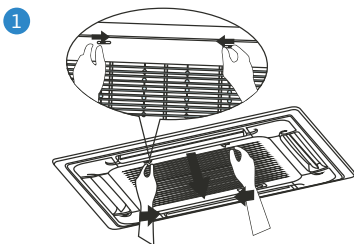

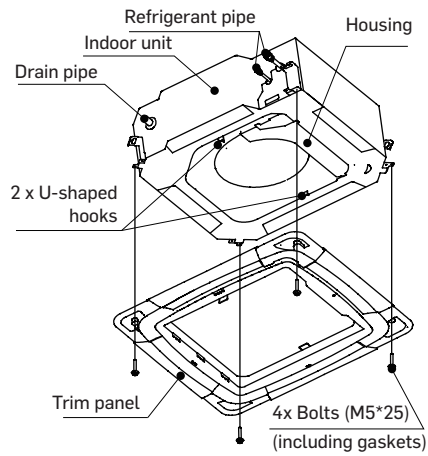
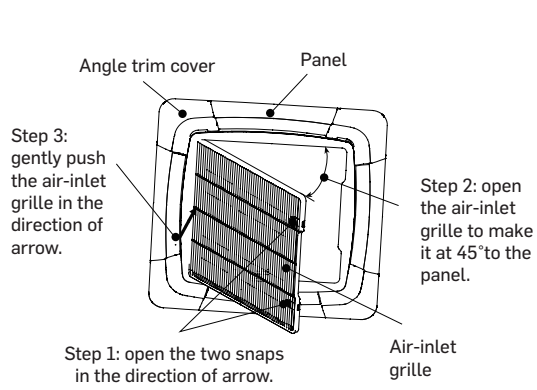

## Dimensions

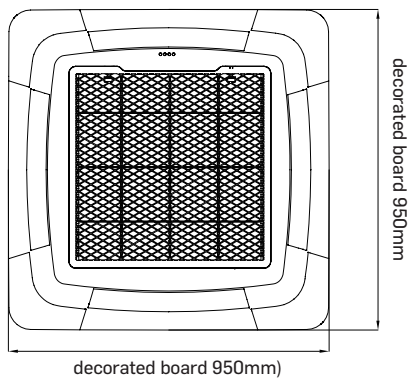
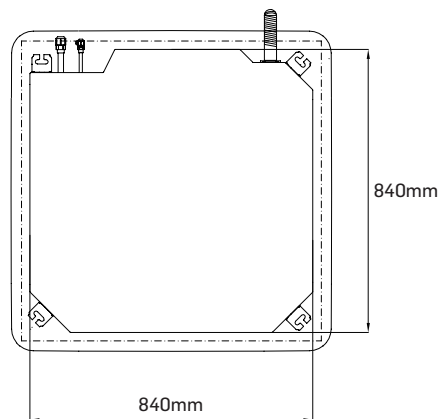

40VU007/009/012/016/018R-7E-QEE

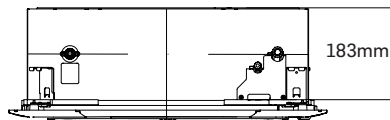

40VU024/028R-7E-QEE

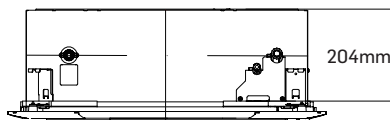

40VU030/038R-7E-QEE

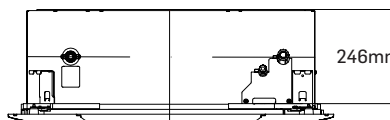

40VU048/054R-7E-QEE

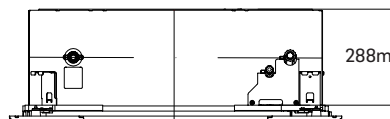





Turn to the experts

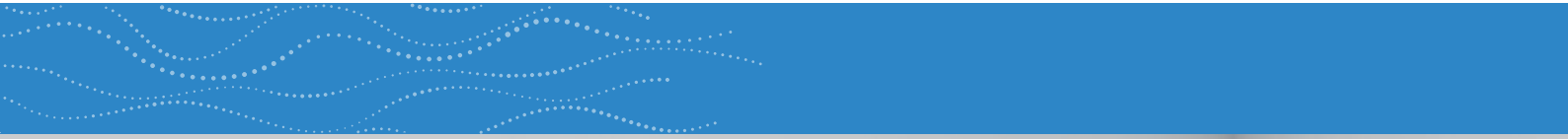

Indoor

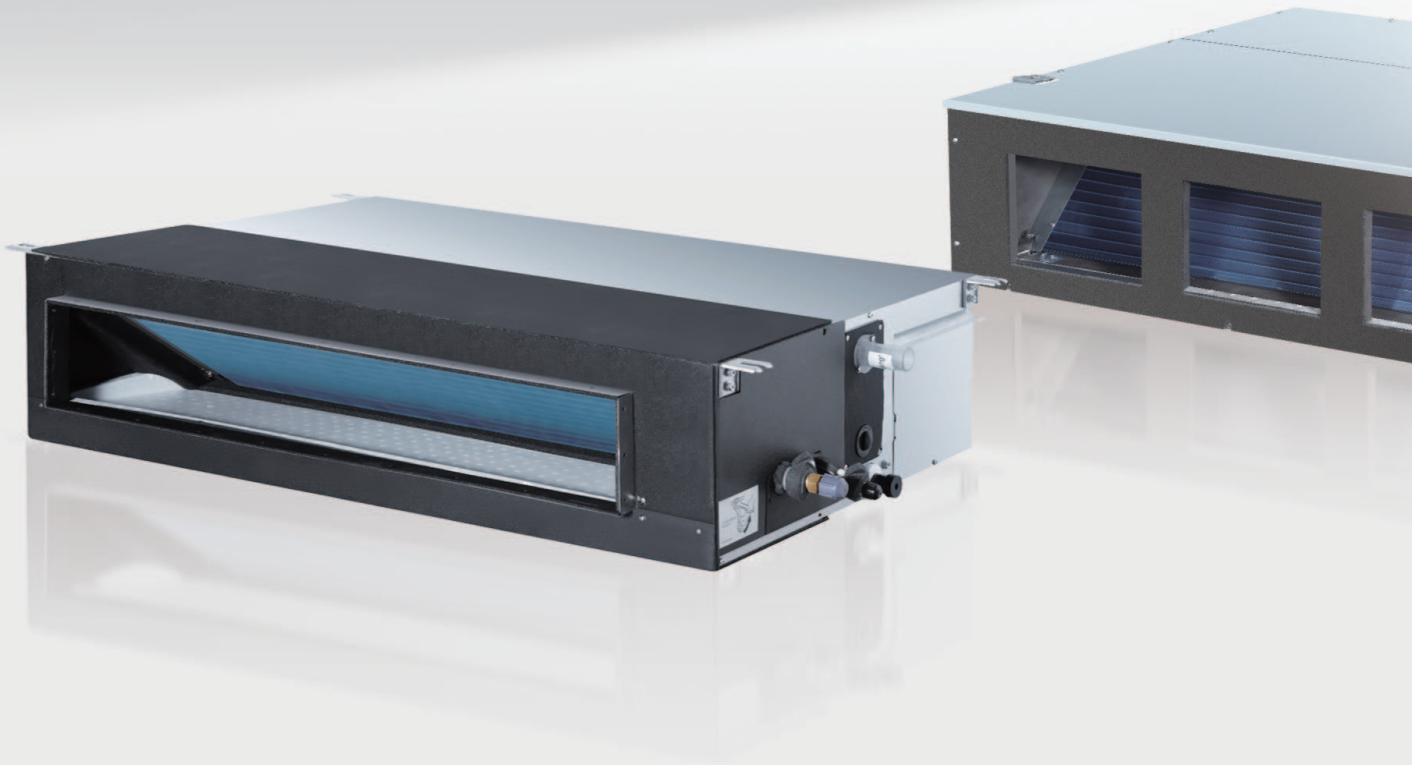



Indoor



Indoor

## Specifications

Model Code	Item	Unit	40VD005L-7E-QEE	40VD007L-7E-QEE	40VD009L-7E-QEE	40VD012L-7E-QEE
Capacity	Model capacity	HP	0,5	0,8	1,0	1,25
	Cooling	kW	1,5	2,2	2,8	3,6
	Heating	kW	1,7	2,5	3,2	4,0
Electrical Parameters	Power supply	Ph/V/Hz	1/220~230/50/60	1/220~230/50/60	1/220~230/50/60	1/220~230/50/60
	Power consumption	W	18	18	18	31
Dimensions (W/D/H)	Net Product	mm	850/420/185	850/420/185	850/420/185	850/420/185
	Shipping Product	mm	1045/540/270	1045/540/270	1045/540/270	1045/540/270
	Net Panel	mm	890/190/100 (outlet panel) 890/290.5/32.4 (inlet panel)	890/190/100 (outlet panel) 890/290.5/32.4 (inlet panel)	890/190/100 (outlet panel) 890/290.5/32.4 (inlet panel)	890/190/100 (outlet panel) 890/290.5/32.4 (inlet panel)
	Shipping Panel (inlet/outlet)	mm	938/335/220	938/335/220	938/335/220	938/335/220
Weight	Product Net/Shipping	kg	16.5/21.5	17.5/22.5	17.5/22.5	17.5/22.5
	Panel Net (In-Out)/Shipping (In-Out)	kg	4/5	4/5	4/5	4/5
External static pressure	Standard	Pa	15	15	15	15
	Maximum	Pa	30	30	30	30
Fan	Air flow (H/M/L)	m³/h	430/370/310	480/420/360	480/420/360	550/430/370
Pressure sound level	Cooling (H/M/L)	dB(A)	26/22/19	27/23/20	27/23/20	30/27/24
	Heating (H/M/L)	dB(A)	26/22/19	27/23/20	27/23/20	30/27/24
Piping	Refrigerant liquid pipe (Ø)	mm	6,35	6,35	6,35	6,35
	Refrigerant gas pipe (Ø)	mm	9,52	9,52	9,52	12,7
	Drain port diameter	mm	25	25	25	25
Drain pump	O-optional, S-standard, N-not incl.	/	S	S	S	S
Accessories (Optional)	Panel Model Code	/	40VPD016L7EQEE	40VPD016L7EQEE	40VPD016L7EQEE	40VPD016L7EQEE

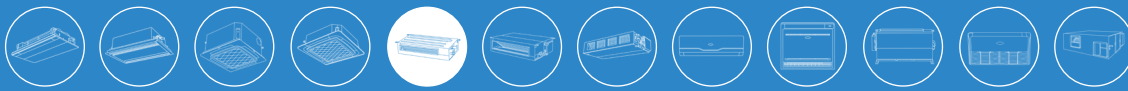

## SLIM DUCT (DC MOTOR 0/15/30 PA) 40VD\*L-7E

- Ultra-thin design: 185 mm height to accommodate in limited space
- DC motor with six fan speeds to provide unique and comfort control
- Built-in drain pump
- Bottom or rear air return
- Static pressure setting 0/30 Pa
- Can be installed with or without discharge & return plenum

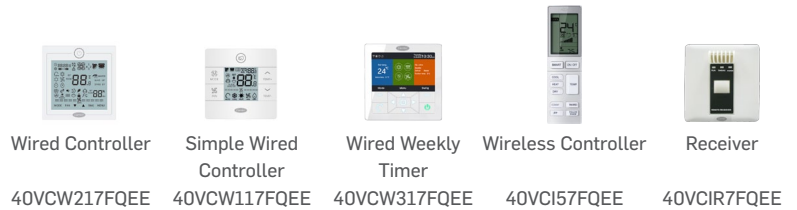

### Specifications



Model Code	Item	Unit	40VD016L-7E-QEE	40VD018L-7E-QEE	40VD024L-7E-QEE
Capacity	Model capacity	HP	1,7	2,0	3,0
	Cooling	kW	4,5	5,6	7,1
	Heating	kW	5,0	6,3	8,0
Electrical Parameters	Power supply	Ph/V/Hz	1/220-230/50/60	1/220-230/50/60	1/220-230/50/60
	Power consumption	W	35	40	50
Dimensions (W/D/H)	Net Product	mm	850/420/185	1170/420/185	1170/420/185
	Shipping Product	mm	1045/540/270	1365/540/270	1365/540/270
	Net Panel	mm	890/190/100 (outlet panel) 890/290.5/32.4 (inlet panel)	1210/190/100 (outlet panel) 1210/290.5/32.4 (inlet panel)	1210/190/100 (outlet panel) 1210/290.5/32.4 (inlet panel)
	Shipping Panel (inlet/outlet)	mm	938/335/220	1258/335/220	1258/335/220
Weight	Product Net/Shipping	kg	18.5/23.5	22.2/28.2	24/30
	Panel Net (In-Out)/Shipping (In-Out)	kg	4/5	5/6	5/6
External static pressure	Standard	Pa	15	15	15
	Maximum	Pa	30	30	30
Fan	Air flow (H/M/L)	m³/h	600/540/460	800/690/580	930/850/750
Pressure sound level	Cooling (H/M/L)	dB(A)	32/29/26	33/30/27	36/33/30
	Heating (H/M/L)	dB(A)	32/29/26	33/30/27	36/33/30
Piping	Refrigerant liquid pipe (Ø)	mm	6,35	6,35	9,52
	Refrigerant gas pipe (Ø)	mm	12,7	12,7	15,88
	Drain port diameter	mm	25	25	25
Drain pump	O-optional, S-standard, N-not incl.	/	S	S	S
Accessories (Optional)	Panel Model Code	/	40VPD016L7EQEE	40VPD024L7EQEE	40VPD024L7EQEE





## SLIM DUCT

(DC MOTOR – 0/15-30 Pa)



Indoor

### Slim, Light Weight & Compact Design

The compact design is 185mm in height and is ideal for installation where space above ceiling is limited.

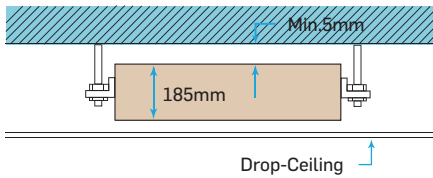

### Built-in Drain Pump

Built-in drain pump (600 mm pump head)

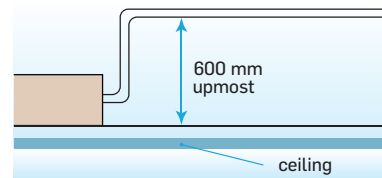

### Easy Installation

Available optional outlet & inlet panels

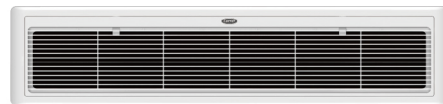

Model Codes	Outlet Panel Dimensions (WxHxD)	Inlet Panel Dimensions (WxHxD)	Shipping Panel (Inlet - Outlet) Dimensions (W X H X D)
Up to 40VPD016L7EQEE	890 x 190 x 100 mm	890 x 291 x 32 mm	938 x 335 x 220 mm
40VPD018-024L7EQEE	1210 x 190 x 100 mm	1210 x 291 x 32 mm	1258 x 335 x 220 mm



## Installation Modes

This series of air conditioners can be arranged in two air return modes:

1. Backward air return (factory default); 2. Downward air return (can be adjusted on site. See the following figures.)

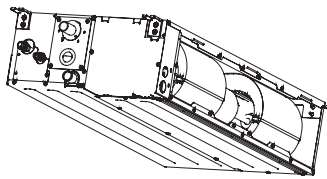

Backward air return

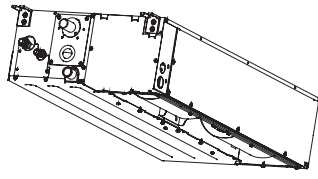

Downward air return 1

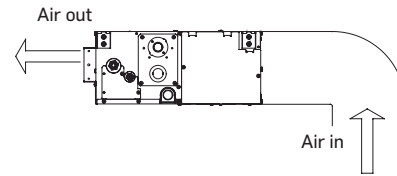

Downward air return 2

Note: the downward air return mode would increase noise 3-5 dB(A). It is recommended to install the air conditioner in downward air return mode 2 if enough space is available.

## Dimensions

40VD005/007/009/012/016L-7E-QEE

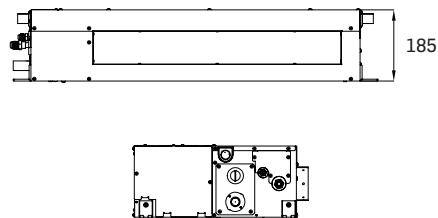
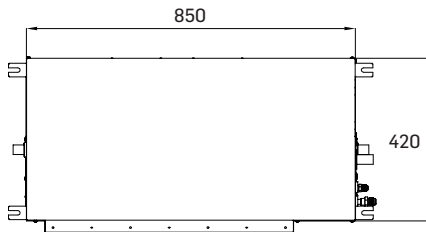

40VD018/024L-7E-QEE

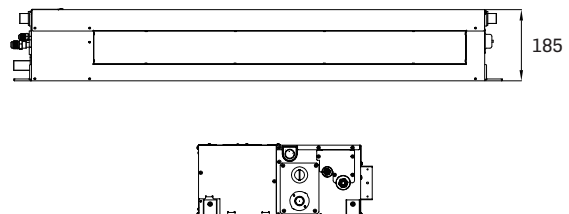
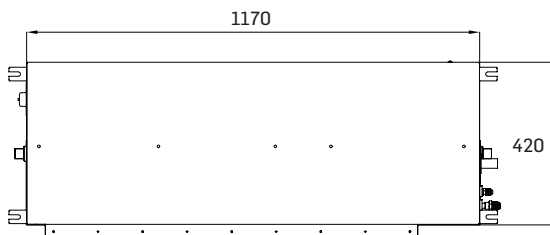

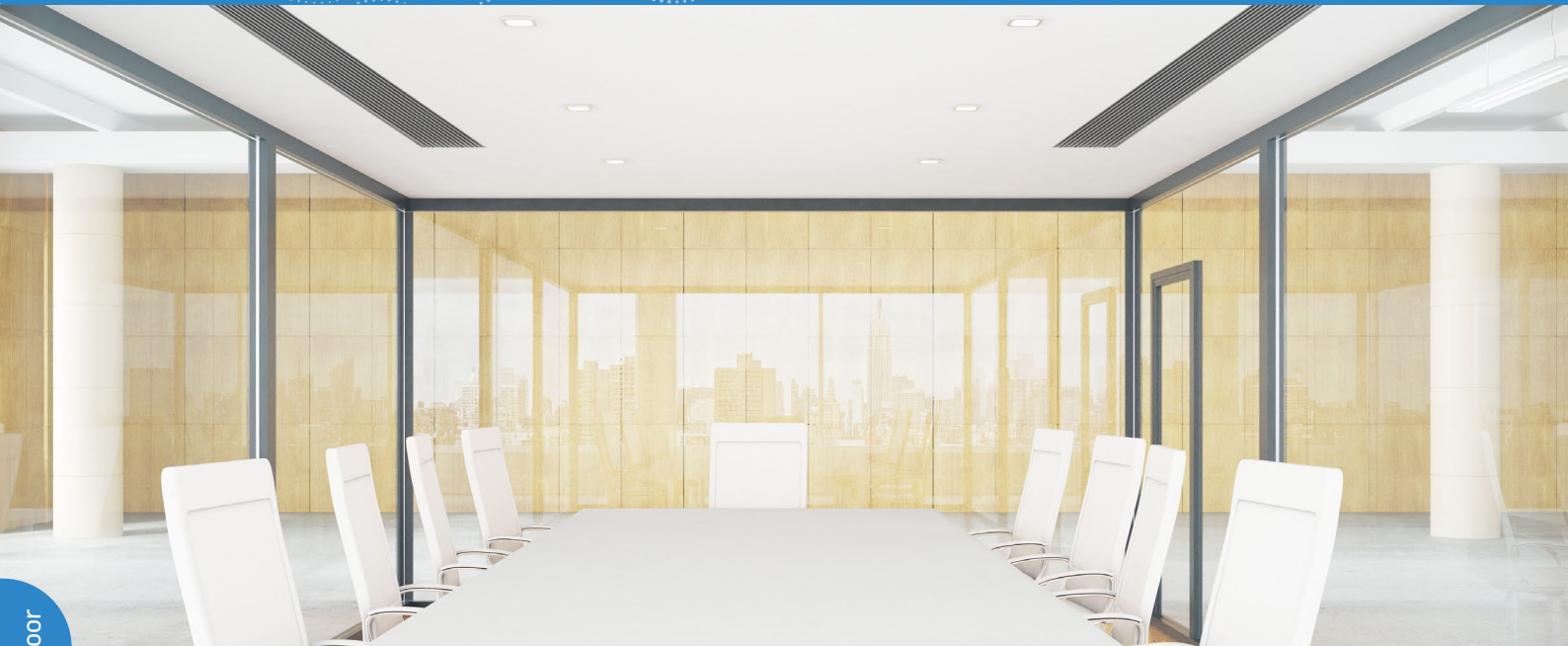

Indoor





## Specifications

Model Code	Item	Unit	40VD005S-7S-QEE	40VD007S-7S-QEE	40VD009S-7S-QEE	40VD012S-7S-QEE	40VD016S-7S-QEE	40VD018S-7S-QEE
Capacity	Model capacity	HP	0.5	0.8	1.0	1.25	1.7	2.0
	Cooling	kW	1,5	2,2	2,8	3,6	4,5	5,6
	Heating	kW	1,7	2,5	3,2	4,0	5,0	6,3
Electrical Parameters	Power supply	Ph/V/Hz	1/220-240/50/60	1/220-240/50/60	1/220-240/50/60	1/220-240/50/60	1/220-240/50/60	1/220-240/50/60
	Power consumption	W	27	29	29	31	50	37
Dimensions (W/D/H)	Net Product	mm	700/700/248	700/700/248	700/700/248	700/700/248	700/700/248	1100/700/248
	Shipping Product	mm	932/835/280	932/835/280	932/835/280	932/835/280	932/835/280	1332/835/280
Weight	Product Net/Shipping	kg	27/32	27/32	27/32	27/32	28.5/33.5	36.8/43.4
External static pressure	Standard	Pa	20	20	20	20	20	20
	Maximum	Pa	200	200	200	200	200	200
Fan	Air flow (H/M/L)	m <sup>3</sup> /h	515/440/390	545/470/390	545/470/390	570/495/420	700/625/550	915/765/640
Pressure sound level	Cooling (H/M/L)	dB(A)	29/27/25	30/28/25	30/28/25	31/29/27	32/30/28	33/31/29
	Heating (H/M/L)	dB(A)	29/27/25	30/28/25	30/28/25	31/29/27	32/30/28	33/31/29
Piping	Refrigerant liquid pipe (Ø)	mm	6,35	6,35	6,35	6,35	6,35	6,35
	Refrigerant gas pipe (Ø)	mm	9.52	9.52	9.52	12,7	12,7	12,7
	Drain port diameter	mm	25	25	25	25	25	25
Drain pump	O-optional, S-standard, N-not incl.	/	S	S	S	S	S	S



## STANDARD STATIC DUCT (DC MOTOR 20/200 Pa) 40VD\*S-7S



-  Elegant slim design with T-shaped lifting eye with adjustable width and length direction for your convenience
-  Hidden installation for a clean and sophisticated appearance
-  Standard draining pump with maximum 1200 mm lift
-  Reserve outside air inlet that helps improve indoor air quality
-  High-quality sealing pipe liner made of heat-retaining EPS material

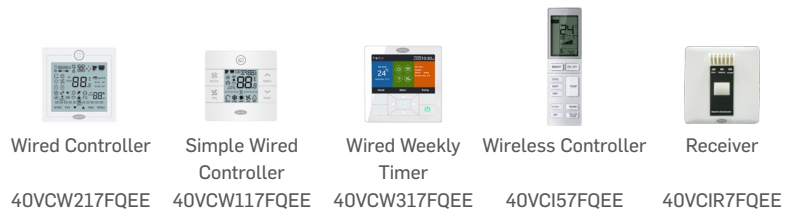

### Specifications



Model Code	Item	Unit	40VD024S-7S-QEE	40VD028S-7S-QEE	40VD030S-7S-QEE	40VD038S-7S-QEE	40VD048S-7S-QEE	40VD054S-7S-QEE
Capacity	Model capacity	HP	2.5	3.0	3.2	4.0	5.0	6.0
	Cooling	kW	7.1	8.0	9.0	11.2	14.0	16.0
	Heating	kW	8.0	9.0	10.0	13.0	16.3	18.0
Electrical Parameters	Power supply	Ph/V/Hz	1/220-240/50/60	1/220-240/50/60	1/220-240/50/60	1/220-240/50/60	1/220-240/50/60	1/220-240/50/60
	Power consumption	W	68	68	94	124	156	194
Dimensions (W/D/H)	Net Product	mm	1100/700/248	1100/700/248	1100/700/248	1500/700/248	1500/700/248	1500/700/248
	Shipping Product	mm	1332/835/280	1332/835/280	1332/835/280	1698/857/305	1698/857/305	1698/857/305
Weight	Product Net/Shipping	kg	36.8/43.4	36.8/43.4	39.4/45.4	48.3/56.5	51.3/59.5	51.3/59.5
External static pressure	Standard	Pa	20	20	20	20	20	20
	Maximum	Pa	200	200	180	180	180	180
Fan	Air flow (H/M/L)	m <sup>3</sup> /h	1275/1050/875	1275/1050/875	1450/1200/1000	2000/1700/1400	2150/1750/1400	2350/1950/1600
Pressure sound level	Cooling (H/M/L)	dB(A)	34/31/29	35/33/30	36/33/30	38/35/32	40/36/32	42/38/34
	Heating (H/M/L)	dB(A)	34/31/29	35/33/30	36/33/30	38/35/32	40/36/32	42/38/34
Piping	Refrigerant liquid pipe (Ø)	mm	9,52	9,52	9,52	9,52	9,52	9,52
	Refrigerant gas pipe (Ø)	mm	15,88	15,88	15,88	15,88	15,88	15,88
	Drain port diameter	mm	25	25	25	25	25	25
Drain pump	O-optional, S-standard, N-not incl.	/	S	S	S	S	S	S





## STANDARD STATIC DUCT (DC MOTOR – 20/200 Pa)



Indoor

### Slim & Compact Design

The compact design is 248mm in height and is ideal for installation where space above ceiling is limited.

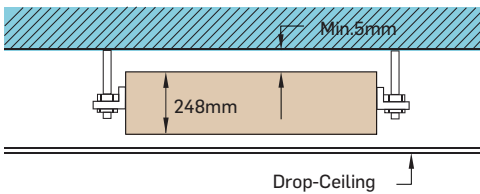

### Built-in Drain Pump

Built-in drain pump (700mm / 1200mm pump head)

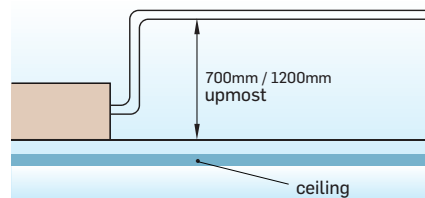

### Standard Static Duct

- Flexible Bottom or Rear Air Return

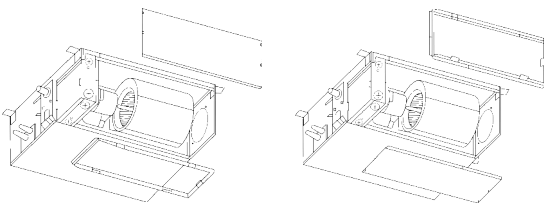

Back air return opening

Below air return opening

- Fixation adjustment

Width and length direction can be adjusted for more convenience



T-shaped lifting eye



Outside air inlet reservation



Better pipe sealing by EPS material



## Dimensions

40VD005S-7S-QEE/40VD007S-7S-QEE/40VD009S-7S-QEE/40VD012S-7S-QEE/40VD016S-7S-QEE

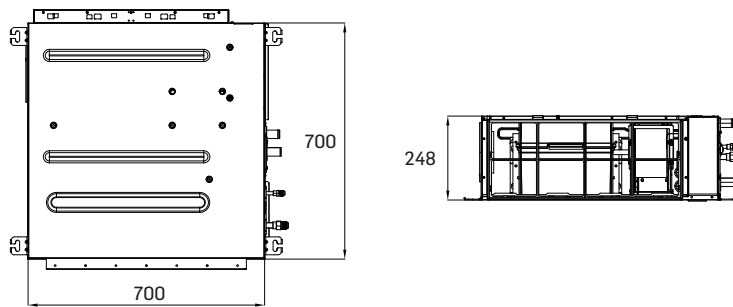

40VD018S-7S-QEE/40VD024S-7S-QEE/40VD028S-7S-QEE/40VD030S-7S-QEE

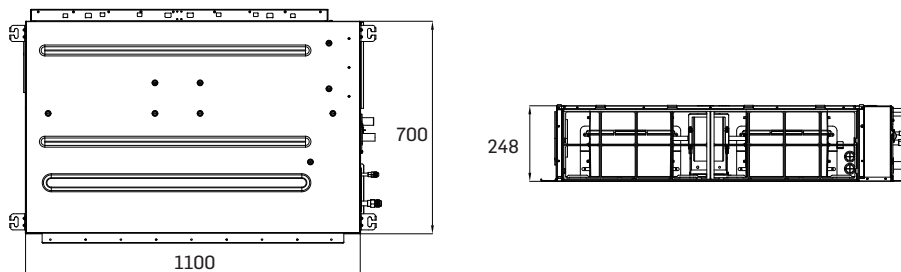

40VD038S-7S-QEE/40VD048S-7S-QEE/40VD054S-7S-QEE

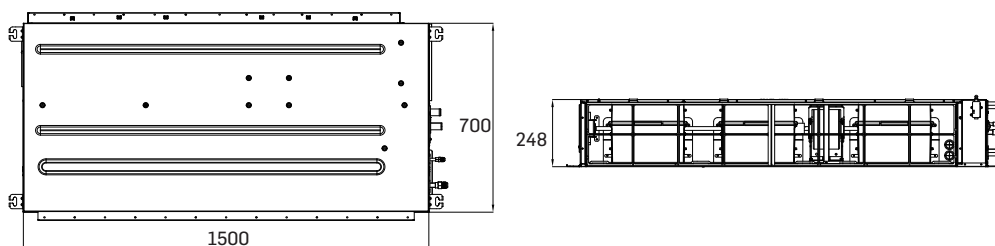



Indoor

## Specifications

Model Code	Item	Unit	40VD007H-7S-QEE	40VD009H-7S-QEE	40VD012H-7S-QEE	40VD015H-7S-QEE	40VD018H-7S-QEE	40VD024H-7S-QEE
Capacity	Model capacity	HP	0,8	1,0	1,25	1,7	2,0	2,5
	Cooling	kW	2,2	2,8	3,6	4,5	5,6	7,1
	Heating	kW	2,5	3,2	4,0	5,0	6,3	8,0
Electrical Parameters	Power supply	Ph/V/Hz	1/220-240/50(60)	1/220-240/50(60)	1/220-240/50(60)	1/220-240/50(60)	1/220-240/50(60)	1/220-240/50(60)
	Power consumption	W	120	120	181	181	181	252.3
Dimensions (W/D/H)	Net Product	mm	750/635/280	750/635/280	750/635/280	750/635/280	750/635/280	950/635/280
	Shipping Product	mm	980/740/335	980/740/335	980/740/335	980/740/335	980/740/335	1180/740/335
Weight	Product Net/Shipping	kg	29/35	29/35	29/35	29/35	29/35	34/41
External static pressure	Standard	Pa	0-200	0-200	0-200	0-200	0-200	0-200
	Maximum	Pa	200	200	200	200	200	200
Fan	Air flow (H/M/L)	m <sup>3</sup> /h	500/410/360	600/510/450	700/580/500	780/680/600	900/780/600	1100/1020/920
Pressure sound level	Cooling (H/M/L)	dB(A)	30/25/23	30/25/23	32/29/26	32/29/26	32/29/26	33/29/25
	Heating (H/M/L)	dB(A)	30/25/23	30/25/23	32/29/26	32/29/26	32/29/26	33/29/25
Piping	Refrigerant liquid pipe (Ø)	mm	6,35	6,35	6,35	6,35	6,35	9,52
	Refrigerant gas pipe (Ø)	mm	9,52	9,52	12,7	12,7	12,7	15,88
	Drain port diameter	mm	31.5	31.5	31.5	31.5	31.5	31.5
Drain pump	O-optional, S-standard, N-not incl.	/	S	S	S	S	S	S



## HIGH STATIC DUCT (DC MOTOR 0/200 PA) 40VD\*H-7S

- Wide range of capacities covered from 2.2 kW to 16 kW with compact 280 mm height
- High-efficiency, low energy consumption DC motor
- 6.35 mm coil copper pipe to ensure more precise & efficient refrigerant distribution
- Top-performing composite material fan wheel blower with light air resistance
- ESP can be changed according to requirements to minimize the noise
- Installer-friendly buckle design of electric box & pull-out fan motor design
- Built-in drain-pump

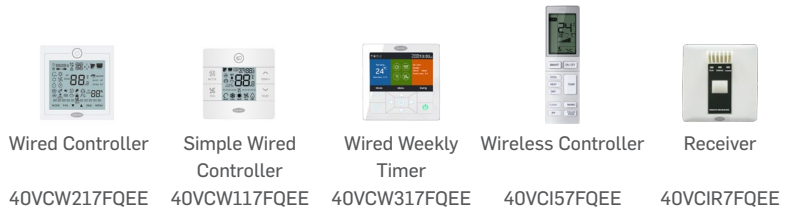
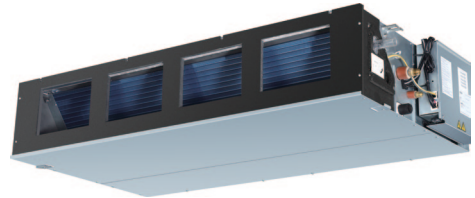

### Specifications



Model Code	Item	Unit	40VD028H-7S-QEE	40VD030H-7S-QEE	40VD036H-7S-QEE	40VD048H-7S-QEE	40VD054H-7S-QEE
Capacity	Model capacity	HP	3,0	3,2	4,0	5,0	6,0
	Cooling	kW	8,0	9,0	11,2	14,0	16,0
	Heating	kW	9,0	10,0	12,5	16,0	18,0
Electrical Parameters	Power supply	Ph/V/Hz	1/220-240/50(60)	1/220-240/50(60)	1/220-240/50(60)	1/220-240/50(60)	1/220-240/50(60)
	Power consumption	W	259.3	259.3	315.6	366.8	366.8
Dimensions (W/D/H)	Net Product	mm	950/635/280	950/635/280	1370/740/280	1370/740/280	1370/740/280
	Shipping Product	mm	1180/740/335	1180/740/335	1555/839/380	1555/839/380	1555/839/380
Weight	Product Net/Shipping	kg	34/41	34/41	54/68	54/68	54/68
External static pressure	Standard	Pa	0-200	0-200	0-200	0-200	0-200
	Maximum	Pa	200	200	200	200	200
Fan	Air flow (H/M/L)	m <sup>3</sup> /h	1500/1320/1220	1500/1320/1220	1700/1510/1400	2280/1920/1780	2280/1920/1780
Pressure sound level	Cooling (H/M/L)	dB(A)	33/29/25	33/29/25	38/36/30	40/34/29	40/34/29
	Heating (H/M/L)	dB(A)	33/29/25	33/29/25	38/36/30	40/34/29	40/34/29
Piping	Refrigerant liquid pipe (Ø)	mm	9,52	9,52	9,52	9,52	9,52
	Refrigerant gas pipe (Ø)	mm	15,88	15,88	15,88	15,88	15,88
	Drain port diameter	mm	31.5	31.5	31.5	31.5	31.5
Drain pump	O-optional, S-standard, N-not incl.	/	S	S	S	S	S



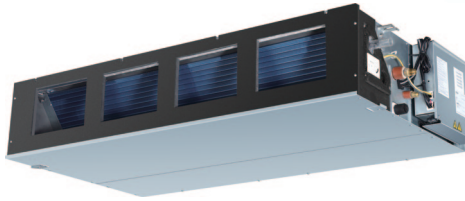

## HIGH STATIC DUCT (DC MOTOR – 0/200 Pa)



Indoor

### Slim, Light Weight & Compact Design

Uniform 280 mm in height. Compact design for easy installation where space over ceiling is limited.

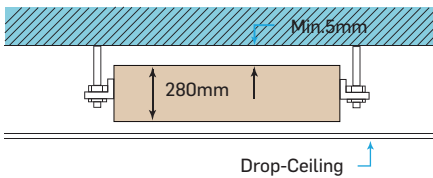

### Built-in Drain Pump

Built-in drain pump (600 mm pump head).

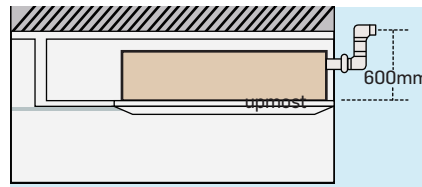

### Energy Saving

- High-efficiency DC fan motor
- 6.35mm heat exchange tube ensures more precise refrigerant distribution and higher efficiency
- High performance composite material wind wheel, light and small air resistance

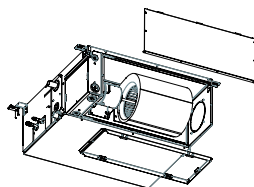
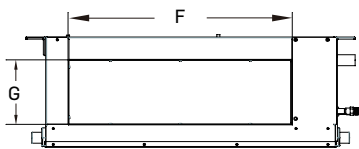

Back air return opening

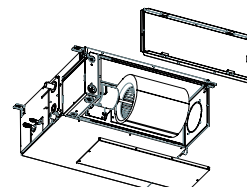

Below air return opening



## Dimensions

40VD007/009/012/015/018H-7S-QEE

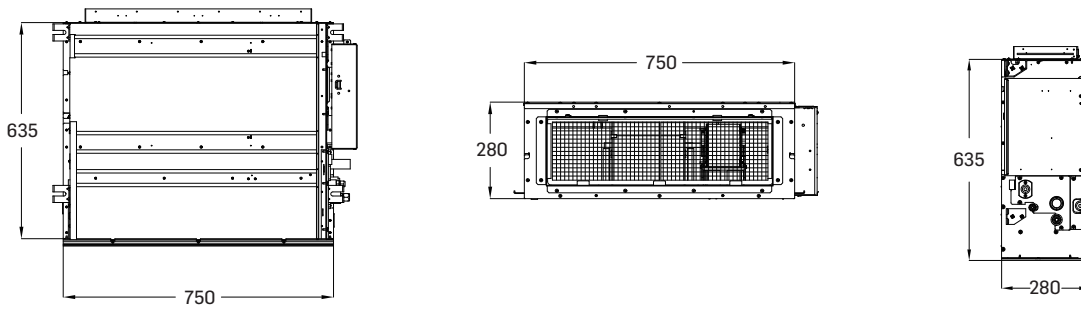

40VD024/028/030H-7S-QEE

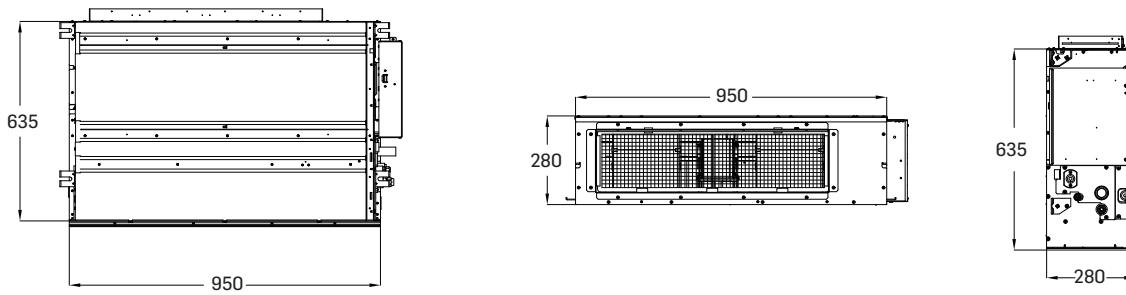

40VD036/048/054H-7S-QEE

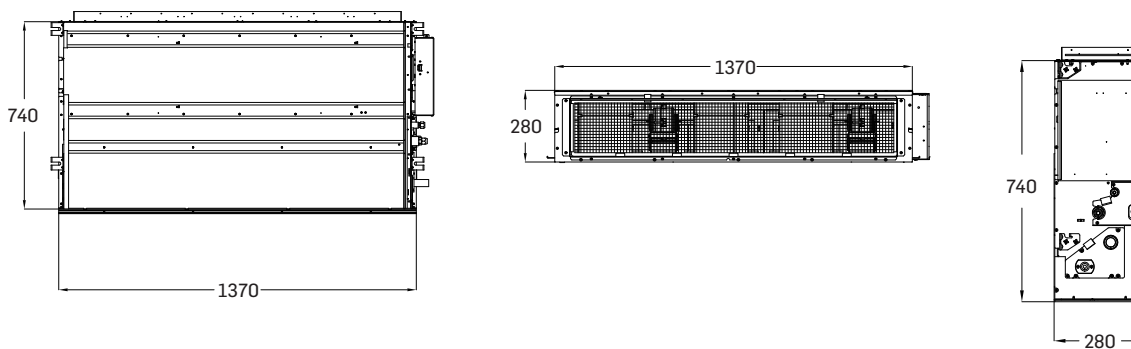

Indoor



Turn to the experts



Indoor





Indoor





Indoor

## Specifications

Model Code	Item	Unit	40VK005S-7S-QEE	40VK007S-7S-QEE	40VK009S-7S-QEE	40VK012S-7S-QEE	40VK016S-7S-QEE
Capacity	Model capacity	HP	0,5	0,8	1,0	1,25	1,7
	Cooling	kW	1,5	2,2	2,8	3,6	4,5
	Heating	kW	1,7	2,5	3,2	4,0	5,0
Electrical Parameters	Power supply	Ph/V/Hz	1/220-240/50/60	1/220-240/50/60	1/220-240/50/60	1/220-240/50/60	1/220-240/50/60
	Power consumption	W	38	38	38	38	52
Dimensions (W/D/H)	Net Product	mm	855/208/280	855/208/280	855/208/280	855/208/280	1115/243/336
	Shipping Product	mm	954/279/355	954/279/355	954/279/355	954/279/355	1206/342/418
Weight	Product Net/Shipping	kg	9.9/12	9.9/12	9.9/12	9.9/12	15.8/18.9
Fan	Air flow (H/M/L)	m <sup>3</sup> /h	500/430/370	550/480/420	600/530/470	630/560/500	800/720/650
Pressure sound level	Cooling (H/M/L)	dB(A)	33/31/29	35/31/29	36/31/29	37/33/29	39/36/34
	Heating (H/M/L)	dB(A)	33/31/29	35/31/29	36/31/29	37/33/29	39/36/34
Piping	Refrigerant liquid pipe (Ø)	mm	6,35	6,35	6,35	6,35	6,35
	Refrigerant gas pipe (Ø)	mm	9,52	9,52	9,52	12,7	12,7
	Drain port diameter	mm	16,8	16,8	16,8	16,8	16,8
Drain pump	O-optional, S-standard, N-not incl.	/	N	N	N	N	N
Accessories (Optional)	PM2.5 Filter	/	40VFK030S7-QEE	40VFK030S7-QEE	40VFK030S7-QEE	40VFK030S7-QEE	40VFK030S7-QEE



## HIGH WALL (DC MOTOR) 40VK\*S-7S

- Stylish & exclusive design with LED display  
Cover panel uses ABS-material to improve surface brightness and durability
- Easy-support clip to enable simple installation
- High-efficiency DC powered fan
- PCB integrated design, flexible piping direction arrangement
- PM 2.5 filter available (optional)



Optional Panel: 40VPU054R7EQEE

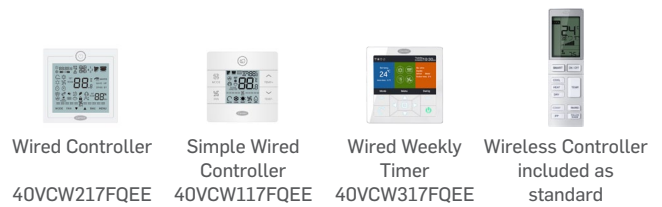

## Specifications



Model Code	Item	Unit	40VK018S-7S-QEE	40VK024S-7S-QEE	40VK028S-7S-QEE	40VK030S-7S-QEE
Capacity	Model capacity	HP	2,0	2,5	3,0	4,0
	Cooling	kW	5,6	7,1	8,0	9,0
	Heating	kW	6,3	8,0	9,0	10,0
Electrical Parameters	Power supply	Ph/V/Hz	1/220~240/50/60	1/220~240/50/60	1/220~240/50/60	1/220~240/50/60
	Power consumption	W	52	52	94	94
Dimensions (W/D/H)	Net Product	mm	1115/243/336	1115/243/336	1316/270/365	1316/270/365
	Shipping Product	mm	1206/342/418	1206/342/418	1403/384/463	1403/384/463
Weight	Product Net/Shipping	kg	15.8/18.9	15.8/18.9	21.8/26.3	21.8/26.3
Fan	Air flow (H/M/L)	m³/h	920/800/720	1010/920/800	1500/1400/1300	1600/1500/1400
Pressure sound level	Cooling (H/M/L)	dB(A)	40/39/35	44/40/36	48/43/40	49/44/41
	Heating (H/M/L)	dB(A)	40/39/35	44/40/36	48/43/40	49/44/41
Piping	Refrigerant liquid pipe (Ø)	mm	6,35	9,52	9,52	9,52
	Refrigerant gas pipe (Ø)	mm	12,7	15,88	15,88	15,88
	Drain port diameter	mm	16,8	16,8	16,8	16,8
Drain pump	O-optional, S-standard, N-not incl.	/	N	N	N	N
Accessories (Optional)	PM2.5 Filter	/	40VFK030S7-QEE	40VFK030S7-QEE	40VFK030S7-QEE	40VFK030S7-QEE



CASING FOR SIZES 0.5HP TO 2.5HP



CASING FOR SIZES 3.0HP TO 4.0HP

## HIGH WALL (DC MOTOR)



Indoor

### Dimensions

MODEL	A	B	C
40VK005/007/009/012S-7S-QEE	855	208	280
40VK016/018/024S-7S-QEE	1115	243	336
40VK028/030S-7S-QEE	1316	220	365

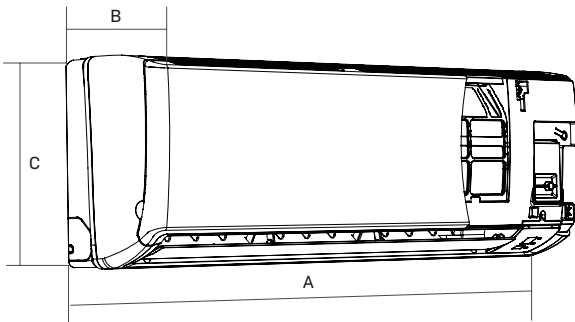

PM 2.5 FILTER (OPTIONAL)

FILTER CODE	DIMENSIONS
40VFK030S7-QEE	225*50*5 MM

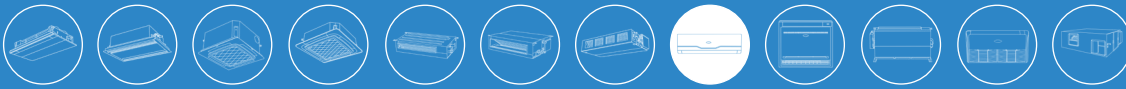

## Easy Service & Maintenance

- Easy removal of air filters for cleaning
- Remote on/off function and alarm function
- Easy access to indoor unit components

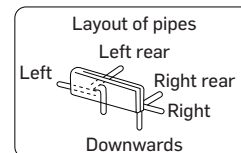
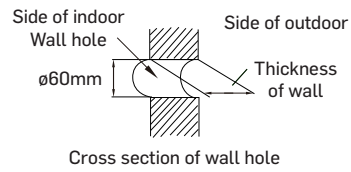
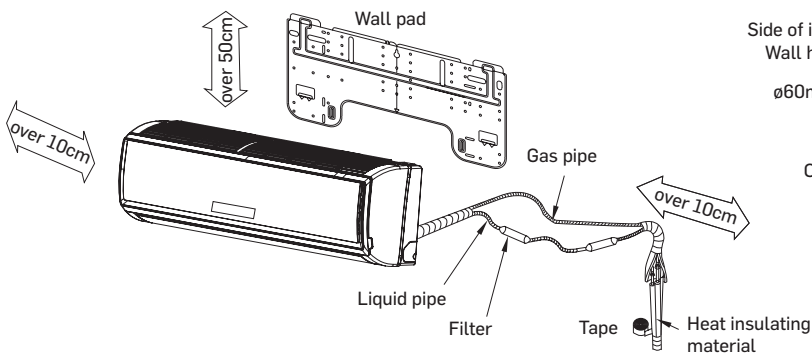
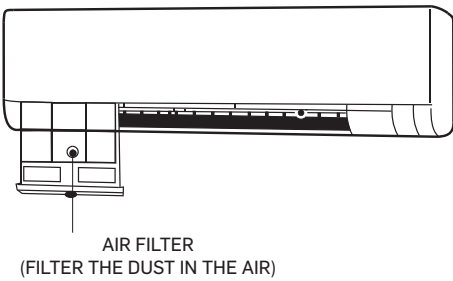





Turn to the experts



Indoor

## TWO-WAY CONSOLE (DC MOTOR) 40VL\*B-7E

- ✂ Compact design makes installation flexible and easy on the floor or against the wall
- 🌀 Five fan speeds and two-way airflow modes that automatically adjust for extra comfort and flexibility  
Automatic adjusting to carpet airflow when switched to two-way airflow mode
- ⚙ Stylish & elegant design



Wired Controller  
40VCW217FQEE



Simple Wired Controller  
40VCW117FQEE



Wired Weekly Timer  
40VCW317FQEE



Wireless Controller  
40VCI57FQEE



## Specifications



COOLING



HEATING

Model Code	Item	Unit	40VL005B-7E-QEE	40VL007B-7E-QEE	40VL009B-7E-QEE	40VL012B-7E-QEE	40VL018B-7E-QEE
Capacity	Model capacity	HP	0,50	0,80	1,0	1,25	2,0
	Cooling	kW	1,5	2,2	2,8	3,6	5,0
	Heating	kW	1,7	2,6	3,2	4,0	5,5
Electrical Parameters	Power supply	Ph/V/Hz	1,220-230V,50/60HZ	1,220-230V,50/60HZ	1,220-230V,50/60HZ	1,220-230V,50/60HZ	1,220-230V,50/60HZ
	Power consumption	W	31	31	31	34	36
Dimensions (W/D/H)	Net Product	mm	700/210/600	700/210/600	700/210/600	700/210/600	700/210/600
	Shipping Product	mm	783/303/695	783/303/695	783/303/695	783/303/695	783/303/695
Weight	Product Net/Shipping	kg	15.2/18.7	15.2/18.7	15.2/18.7	15.2/18.7	15.2/18.7
Fan	Air flow (H/M/L)	m <sup>3</sup> /h	540/460/390/310/270	540/460/390/310/270	540/460/390/310/270	580/500/420/350/270	620/540/460/390/270
Pressure sound level	Cooling (H/M/L)	dB(A)	45/42/38/33/30	45/42/38/33/30	45/42/38/33/30	47/44/40/36/30	48/45/42/38/30
	Heating (H/M/L)	dB(A)	45/42/38/33/30	45/42/38/33/30	45/42/38/33/30	47/44/40/36/30	48/45/42/38/30
Piping	Refrigerant liquid pipe (Ø)	mm	6,35	6,35	6,35	6,35	6,35
	Refrigerant gas pipe (Ø)	mm	12,7	12,7	12,7	12,7	12,7
	Drain port diameter	mm	16	16	16	16	16
Drain pump	O-optional, S-standard, N-not incl.	/	N	N	N	N	N

Indoor

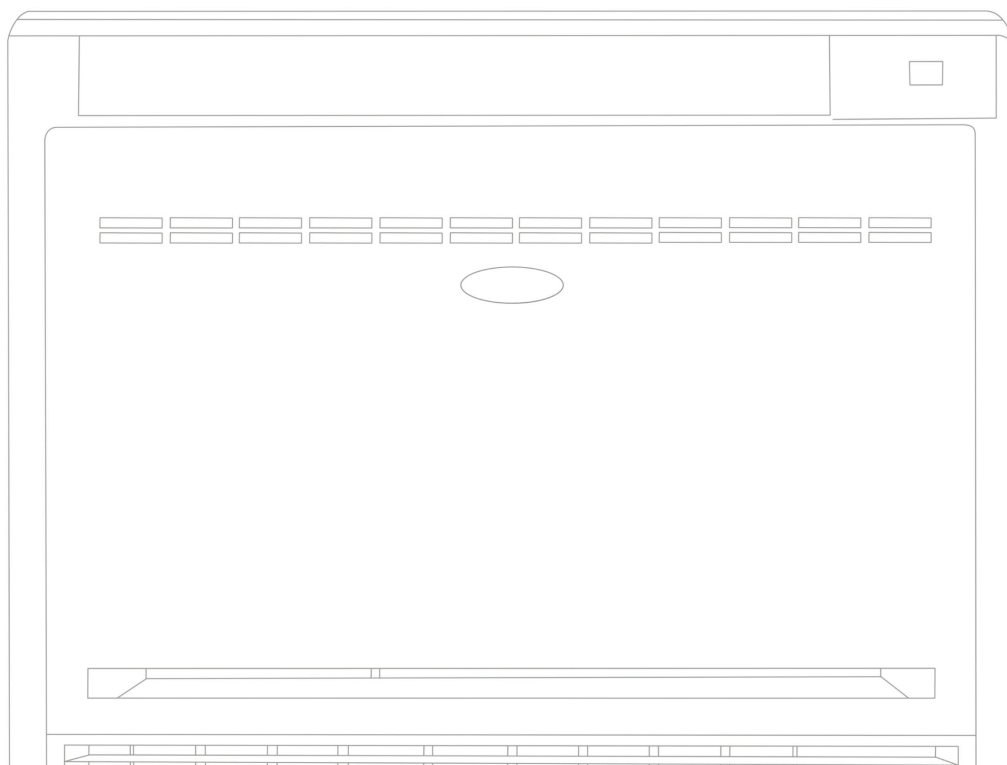



## TWO-WAY CONSOLE (DC MOTOR)



Indoor

### Easy Installation

- The indoor units can be installed on the floor or on the wall. It's flexibility allows for easy installation.

### Compact Unit, Space Saving

- The console indoor unit is very slim and will be harmonious with any room. It can be placed at the corner, and is very space saving.

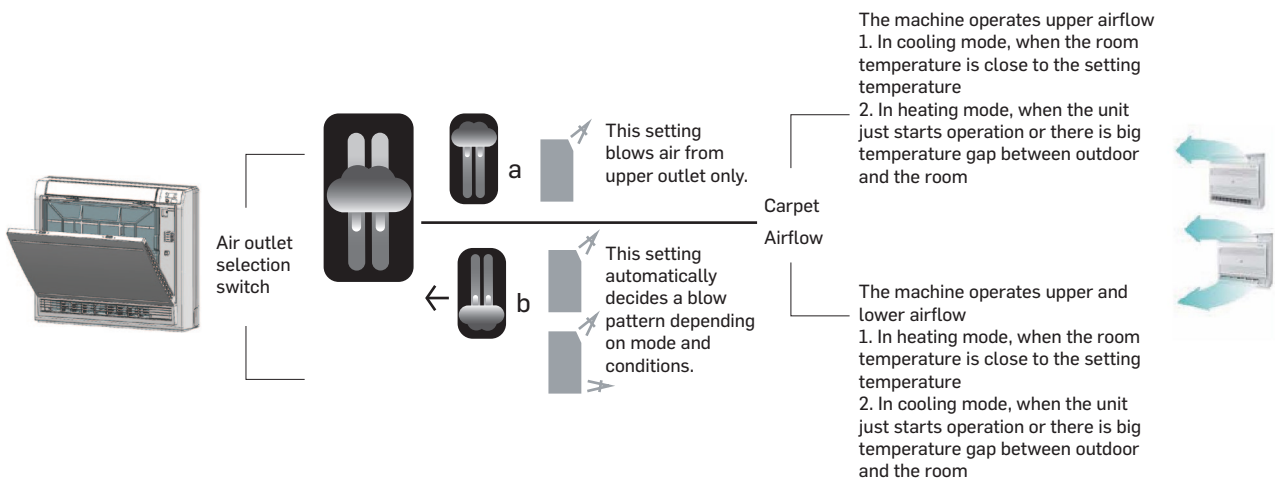



## Dimensions

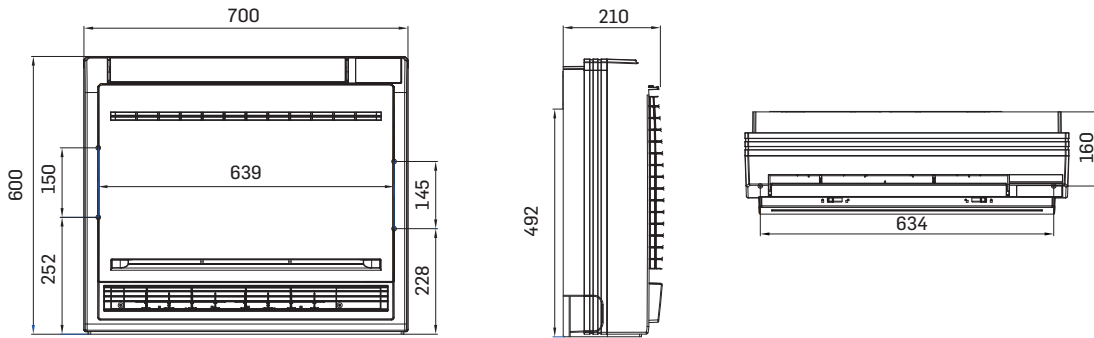

## Installation & Service

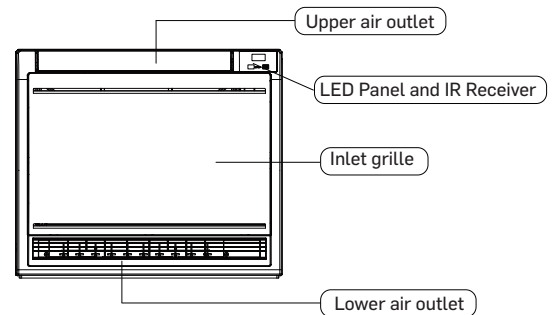
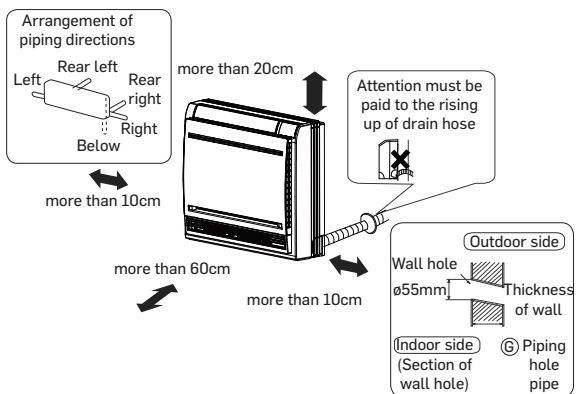

- Hold the front panel by the tabs on the both sides and lift it until it stops with a click.

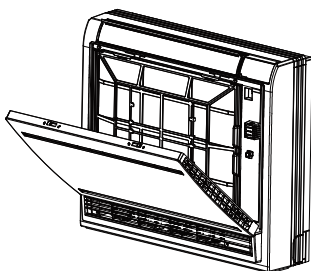

- Loosen the marked four screws and open the grille.

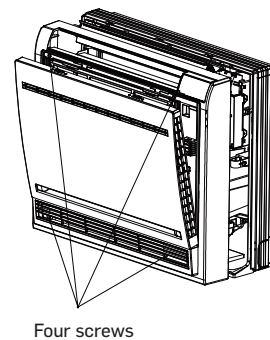







Indoor

## CONSOLE - RECESSED (AC MOTOR) 40VL\*R-7G

-  Compact design suitable for installation space as little as 221 mm
-  Good solution for installation beneath a window. Washable filter fitted as standard
-  30 Pa available static pressure for small ducting or higher efficiency filter



Wired Controller  
40VCW217FQEE



Simple Wired Controller  
40VCW117FQEE



Wired Weekly Timer  
40VCW317FQEE



Wireless Controller  
40VCI57FQEE





## Specifications



COOLING



HEATING

Model Code	Item	Unit	40VL007R-7G-QEE	40VL009R-7G-QEE	40VL012R-7G-QEE
Capacity	Model capacity	HP	0,8	1,0	1,25
	Cooling	kW	2,2	2,8	3,6
	Heating	kW	2,5	3,2	4,0
Electrical Parameters	Power supply	Ph/V/Hz	1/220-230/50/60	1/220-230/50/60	1/220-230/50/60
	Power consumption	W	110	110	110
Dimensions (W/D/H)	Net Product	mm	1116/221/624	1116/221/624	1116/221/624
	Shipping Product	mm	1198/295/707	1198/295/707	1198/295/707
Weight	Product Net/Shipping	kg	29/37	29/37	29/37
External static pressure	Standard	Pa	0	0	0
	Maximum	Pa	30	30	30
Fan	Air flow (H/M/L)	m <sup>3</sup> /h	750/650/550	750/650/550	750/650/550
Pressure sound level	Cooling (H/M/L)	dB(A)	38/35/33	38/35/33	40/37/35
	Heating (H/M/L)	dB(A)	38/35/33	38/35/33	40/37/35
Piping	Refrigerant liquid pipe (Ø)	mm	6,35	6,35	6,35
	Refrigerant gas pipe (Ø)	mm	9,52	9,52	12,7
	Drain port diameter	mm	20	20	20
Drain pump	O-optional, S-standard, N-not incl.	/	N	N	N

Indoor

## Dimensions

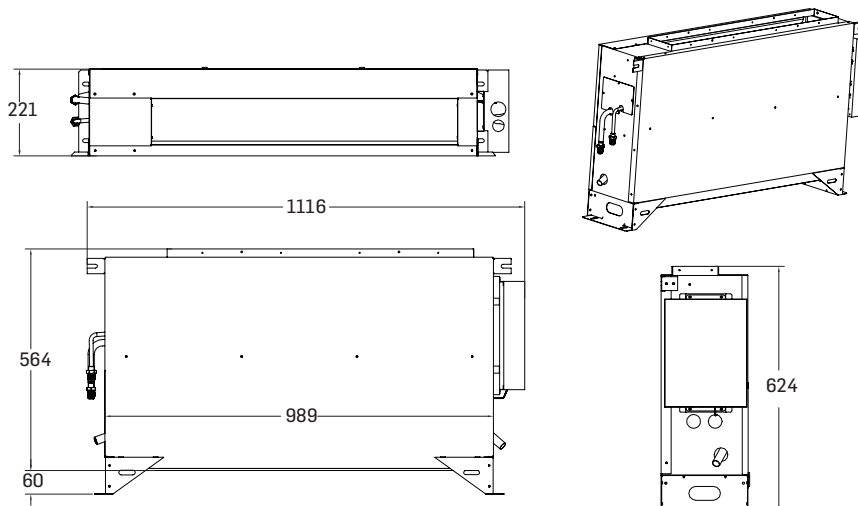



Indoor

## FLEX CEILING FLOOR (AC MOTOR) 40VC\*F-7G

- Flexible installation, on the floor or under the ceiling
- Slim design – 199 mm
- Multiple direction for connection pipe setting



Wired Controller  
40VCW217FQEE



Simple Wired Controller  
40VCW117FQEE



Wired Weekly Timer  
40VCW317FQEE



Wireless Controller  
40VCI57FQEE



## Specifications



COOLING



HEATING

Model Code	Item	Unit	40VC009F-7G-QEE	40VC012F-7G-QEE	40VC016F-7G-QEE	40VC018F-7G-QEE	40VC024F-7G-QEE
Capacity	Model capacity	HP	1,0	1,25	1,7	2,0	2,5
	Cooling	kW	2,8	3,6	4,5	5,6	7,1
	Heating	kW	3,2	4,0	5,0	6,3	8,0
Electrical Parameters	Power supply	Ph/V/Hz	1/220~230/50/60	1/220~230/50/60	1/220~230/50/60	1/220~230/50/60	1/220~230/50/60
	Power consumption	W	100	100	100	100	100
Dimensions (W/D/H)	Net Product	mm	990/655/199	990/655/199	990/655/199	990/655/199	990/655/199
	Shipping Product	mm	1160/730/280	1160/730/280	1160/730/280	1160/730/280	1160/730/280
Weight	Product Net/Shipping	kg	28.3/34.3	28.3/36.4	28.3/36.4	28.3/36.4	28.3/36.4
Fan	Air flow (H/M/L)	m <sup>3</sup> /h	800/710/580	800/710/580	800/710/580	800/710/580	800/710/580
Pressure sound level	Cooling (H/M/L)	dB(A)	38/35/33	38/35/33	40/37/35	40/37/35	40/37/35
	Heating (H/M/L)	dB(A)	38/35/33	38/35/33	40/37/35	40/37/35	40/37/35
Piping	Refrigerant liquid pipe (Ø)	mm	6,35	6,35	6,35	6,35	9,52
	Refrigerant gas pipe (Ø)	mm	9,52	12,7	12,7	12,7	15,88
	Drain port diameter	mm	20	20	20	20	20
Drain pump	O-optional, S-standard, N-not incl.	/	N	N	N	N	N

Indoor

## Dimensions

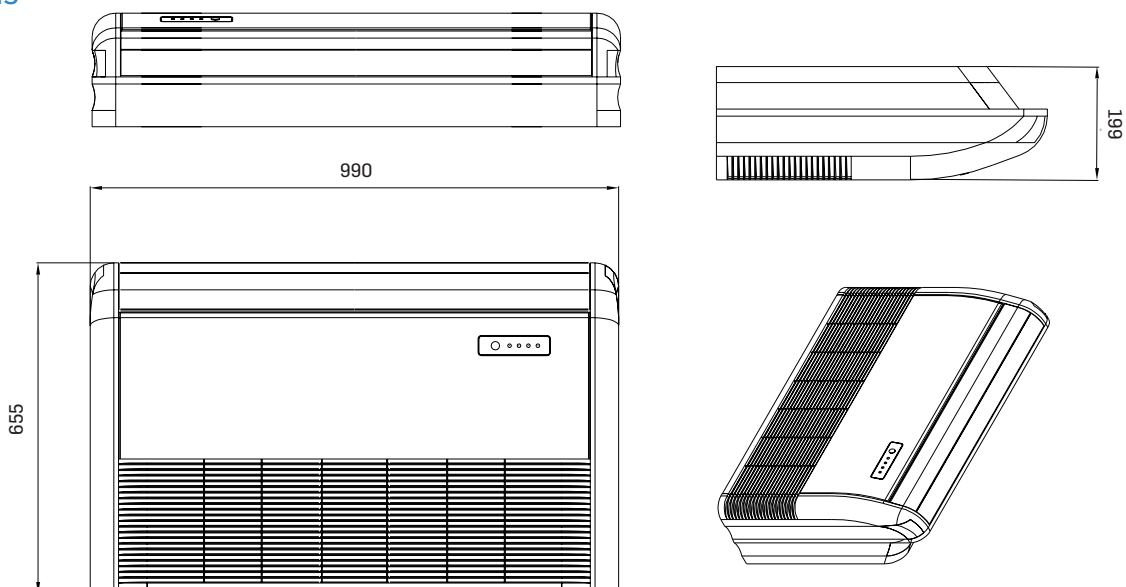



Indoor

## Specifications

Model Code	Item	Unit	40VC009F-7S-QEE	40VC012F-7S-QEE	40VC016F-7S-QEE	40VC018F-7S-QEE	40VC024F-7S-QEE
Capacity	Model capacity	HP	1,0	1,25	1,7	2,0	2,5
	Cooling	kW	2,8	3,6	4,5	5,6	7,1
	Heating	kW	3,2	4,0	5,0	6,3	8,0
Electrical Parameters	Power supply	Ph/V/Hz	1,220~230,50/60	1,220~230,50/60	1,220~230,50/60	1,220~230,50/60	1,220~230,50/60
	Power consumption	W	35	35	45	45	80
Dimensions (W/D/H)	Net Product	mm	1000*230*680	1000*230*680	1000*230*680	1000*230*680	1330*230*680
	Shipping Product	mm	1100*305*779	1100*305*779	1100*305*779	1100*305*779	1425*305*779
Weight	Product Net/Shipping	kg	27.9/33.6	27.9/33.6	27.9/33.6	27.9/33.6	35.8/42.1
Fan	Air flow (H/M/L)	m <sup>3</sup> /h	820/750/690	820/750/690	950/820/690	950/820/690	1420/1270/1240
Pressure sound level	Cooling (H/M/L)	dB(A)	38/36/34	38/36/34	42/38/35	42/38/35	46/44/41
	Heating (H/M/L)	dB(A)	38/36/34	38/36/34	42/38/35	42/38/35	46/44/41
Piping	Refrigerant liquid pipe (Ø)	mm	6,35	6,35	6,35	6,35	9,52
	Refrigerant gas pipe (Ø)	mm	9,52	12,7	12,7	12,7	15,88
	Drain port diameter	mm	20	20	20	20	20
Drain pump	O-optional, S-standard, N-not incl.	/	N	N	N	N	N
Accessories (Optional)	PM2.5 Filter	/	40VFC018F7-QEE	40VFC018F7-QEE	40VFC018F7-QEE	40VFC018F7-QEE	40VFC054F7-QEE



## FLEX CEILING FLOOR (DC MOTOR) 40VC\*F-7S

- Ultra-compact design (230 mm), elegant balance of flexibility and simplicity
- Appealing, even without screen cover
- Easy installation and maintenance  
Easy access to PCB
- Simultaneous left and right swing control for optional freestyle airflow
- PM 2.5 filter (optional)

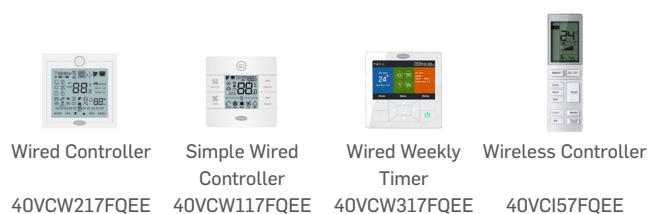

### Specifications



Model Code	Item	Unit	40VC028F-7S-QEE	40VC030F-7S-QEE	40VC038F-7S-QEE	40VC048F-7S-QEE	40VC054F-7S-QEE
Capacity	Model capacity	HP	3,0	3,2	4,0	5,0	6,0
	Cooling	kW	8,0	9,0	11,2	14,0	16,0
	Heating	kW	9,0	10,0	12,5	16,0	18,0
Electrical Parameters	Power supply	Ph/V/Hz	1,220~230,50/60	1,220~230,50/60	1,220~230,50/60	1,220~230,50/60	1,220~230,50/60
	Power consumption	W	105	105	126	126	126,0
Dimensions (W/D/H)	Net Product	mm	1330*230*680	1330*230*680	1650*230*680	1650*230*680	1650*230*680
	Shipping Product	mm	1425*305*779	1425*305*779	1750*305*779	1750*305*779	1750*305*779
Weight	Product Net/Shipping	kg	35.8/42.1	35.8/42.1	43.5/50.5	43.5/50.5	43.5/50.5
Fan	Air flow (H/M/L)	m <sup>3</sup> /h	1570/1420/1240	1570/1420/1240	2110/1990/1750	2110/1990/1750	2110/1990/1750
Pressure sound level	Cooling (H/M/L)	dB(A)	47/44/41	47/44/41	50/46/43	50/46/43	50/46/43
	Heating (H/M/L)	dB(A)	47/44/41	47/44/41	50/46/43	50/46/43	50/46/43
Piping	Refrigerant liquid pipe (Ø)	mm	9,52	9,52	9,52	9,52	9,52
	Refrigerant gas pipe (Ø)	mm	15,88	15,88	15,88	15,88	15,88
	Drain port diameter	mm	20	20	20	20	20
Drain pump	O-optional, S-standard, N-not incl.	/	N	N	N	N	N
Accessories (Optional)	PM2.5 Filter	/	40VFC054F7-QEE	40VFC054F7-QEE	2 x 40VFC054F7-QEE	2 x 40VFC054F7-QEE	2 x 40VFC054F7-QEE

Indoor



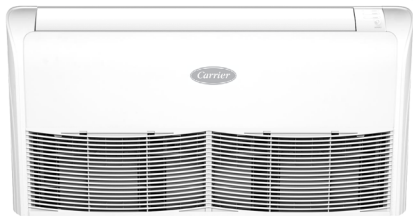

## FLEX CEILING FLOOR (DC MOTOR)



Indoor

### Easy Service & Maintenance

- Easy removal of air filters for cleaning
- Easy access to indoor unit components
- Remote on/off function and alarm function

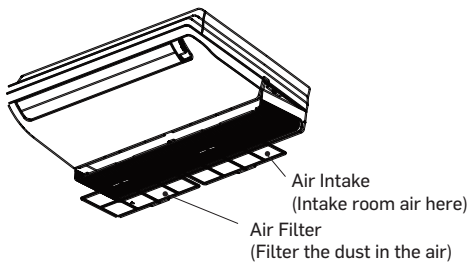

### Design Aesthetics

- The visually ultra thin body features wave-shaped vents on both sides that embody multiple levels of design
- Visually screw-free, yet easy to maintain



### PM 2.5 Filter (Optional)

UNIT MODEL	FILTER MODEL NAME	FILTER SIZE	FILTER PIC
40VC009/012/016/018F-7S-QEE	40VFC018F7-QEE	133*52*10	
40VC024/028/030F-7S-QEE	40VFC054F7-QEE	224*69.3*10	
40VC038/048/054F-7S-QEE	2*40VFC054F7-QEE	2*224*69.3*10	

### Multiple Air Distribution Directions

On pressing the SWING button, the flap changes between the following positions:

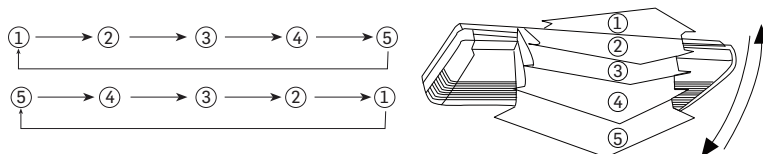



## Dimensions

40VC009/012/016/018F-7S-QEE

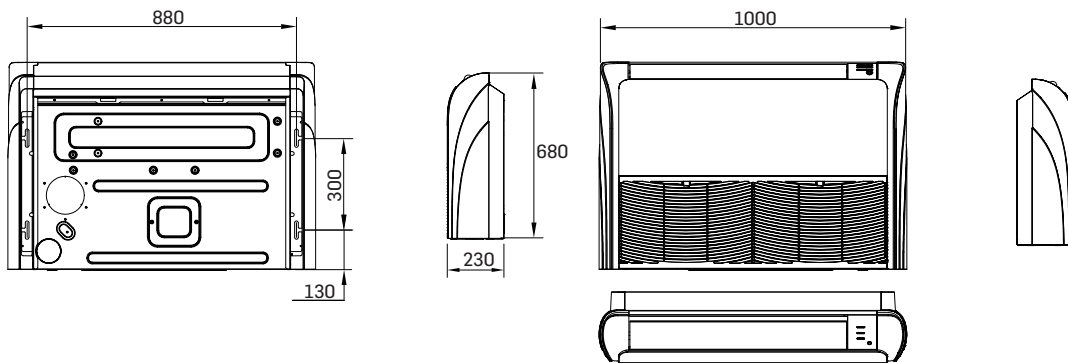

40VC024/028/030F-7S-QEE

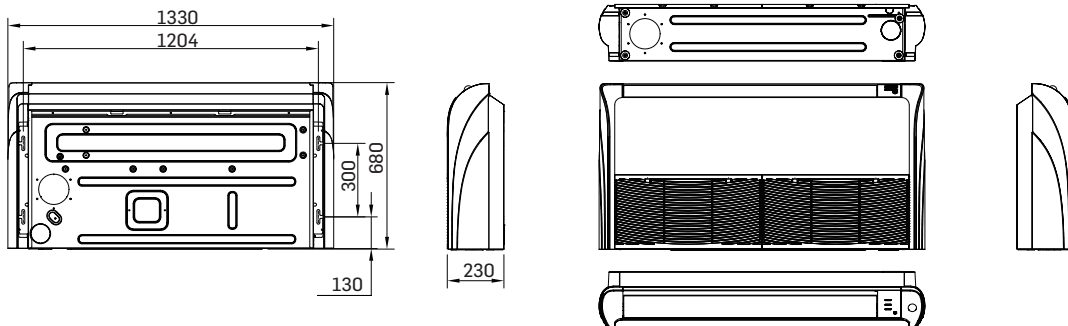

40VC038/048/054F-7S-QEE

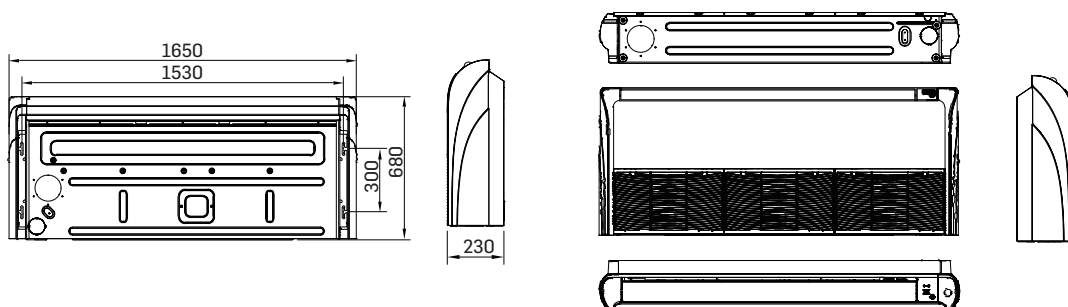



Turn to the experts



Indoor





Indoor



Turn to the experts



## HRV (AC Motor) 40VH\*A-7G

-  Efficiency up to 78% on temperature exchanger & 65% on enthalpy (cooling)
-  Independent 220V power supply
-  Can run in slight over-pressure or under-pressure mode  
Efficient heat recovery air processing

Note: This unit doesn't require refrigerant connection







## Specifications

Model/indoor unit	Item	Unit	40VH015A-7G-QEE	40VH026A-7G-QEE
Electrical Parameters	Power supply	Ph/V/Hz	1/220~230/50/60	1/220~230/50/60
	Power consumption	W	100	120
Dimensions (W/D/H)	Net Product	mm	813/553/276	813/553/276
	Shipping Product	mm	1000/760/320	1000/760/320
Weight	Product Net/Shipping	kg	28.7/31.2	28.7/31.2
External static pressure	Standard	Pa	80	60
	Maximum	Pa	80	60
Fan	Maximum	m <sup>3</sup> /h	150	260
Sound level	Sound pressure level (H/L)	dB(A)	44/43	44/43
	Sound power level (H/L)	dB(A)	55/54	55/54
Controller	Wired (Standard)	Specific	S	S

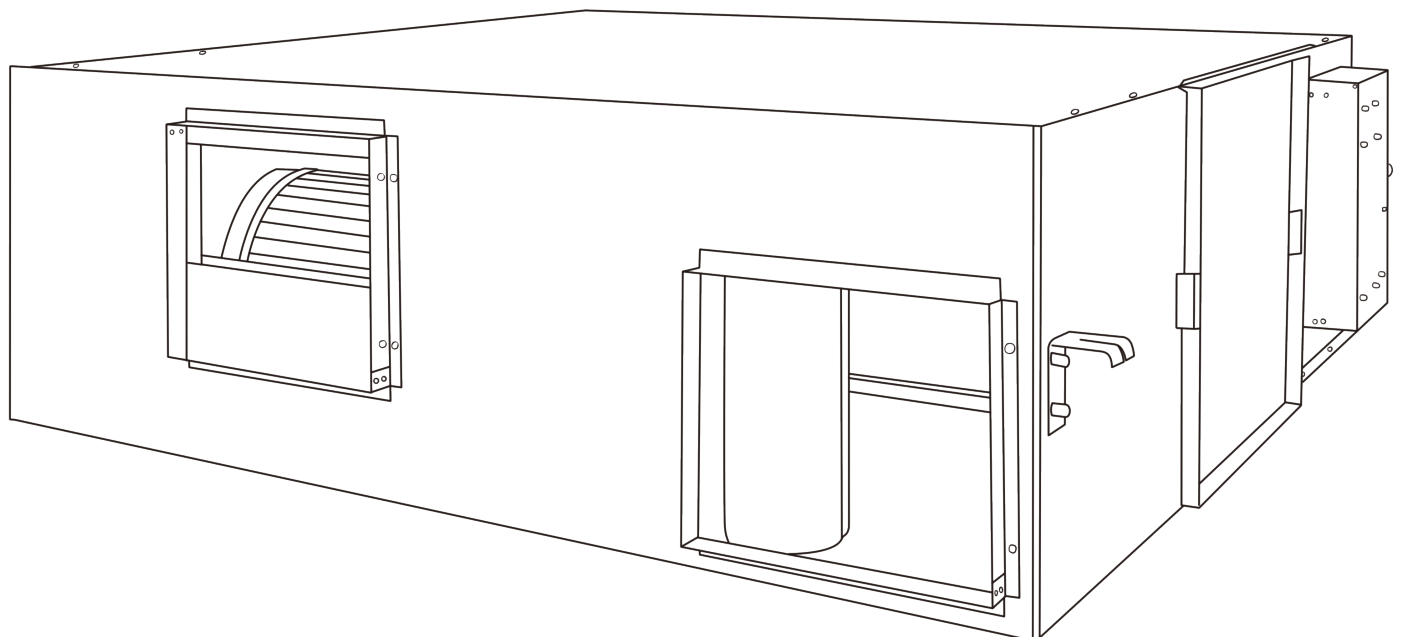

Indoor



Turn to the experts



## HRV (AC MOTOR)



Indoor

### Dimensions

40VH015/026A-7G-QEE

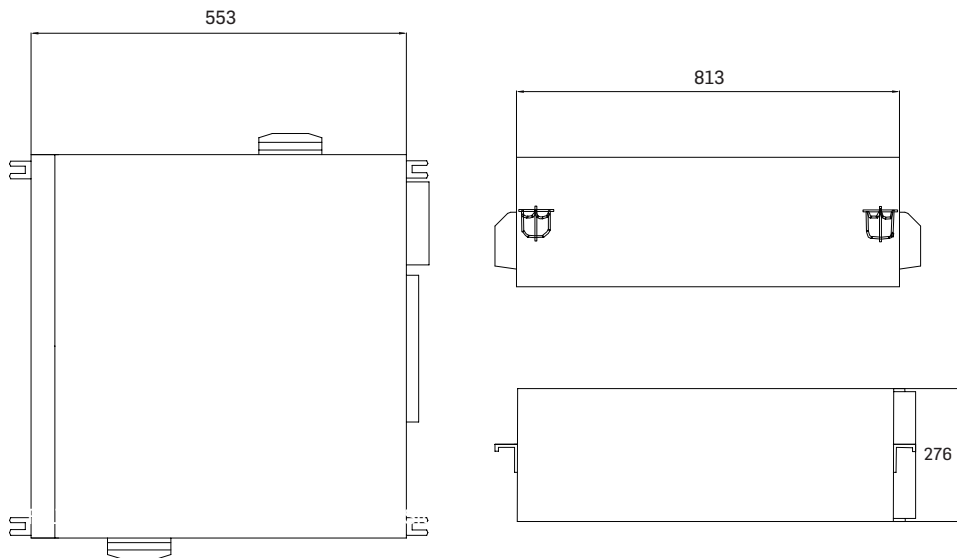



## Dimensions

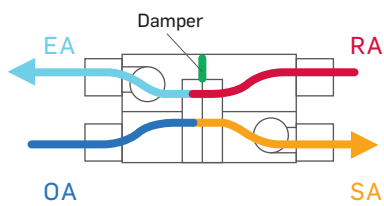

## Air to Air Heat Exchanger Process Patterns

### Heating Mode

Outdoor cold air and hot return air cross through the heat recovery element. The unit blows warmer air inside the ducts to the room.

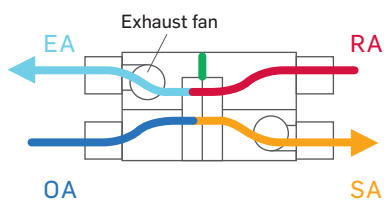

### Cooling Mode

Outdoor hot air and cold return air cross through the heat recovery element. The unit blows cooler air inside the ducts to the room.

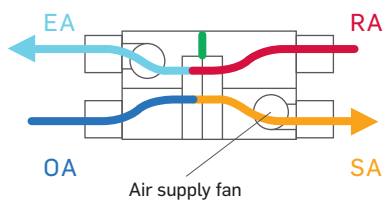

### Free Cooling Mode

Outdoor air passes without heat recovery treatment.



Turn to the experts

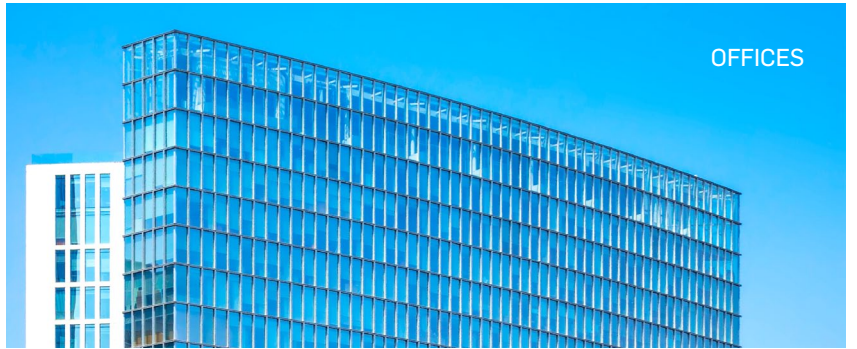

OFFICES



RETAIL



ADMINISTRATIONS





## AHU DX KITS CONNECTION

123	TA CONTROL TYPE
125	DDC CONTROL TYPE
127	UNIT STRUCTURE





AHU Kit



## Air Handling Unit DX Coil kit (TA Control)

### Easy Installation

- Carrier offers a range of connection kits to connect VRF outdoor units to 3rd party DX AHU (R410A)
- 2 connections are possible:
  - Mixed with VRF indoor units, AHU capacity should less than 30% of total capacity
  - AHU alone
- In both cases (50% < indoor Max connection ratio < 100%)
- Compatible to XCT7 Top Discharge up to 60HP (3 kits) & XCT7 Side Discharge (8/10/12HP)
- Compatible with all XCT7 VRF control solutions

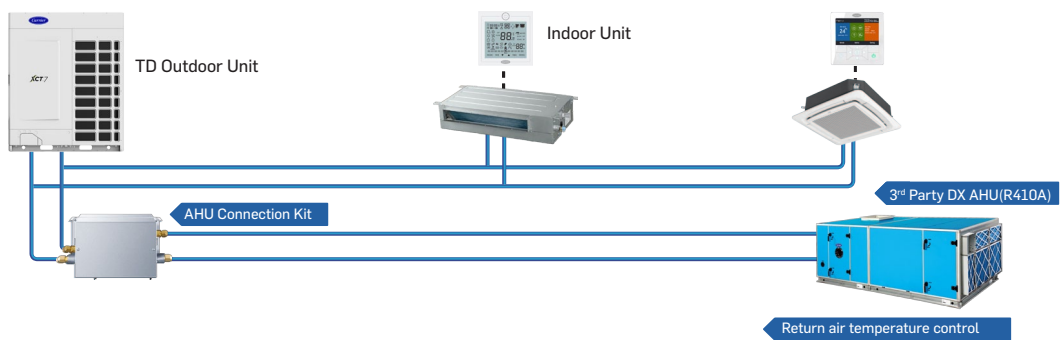

### AHU Kit Configuration

Carrier's AHU connection kit consists the following 4 parts, where controller is optional:

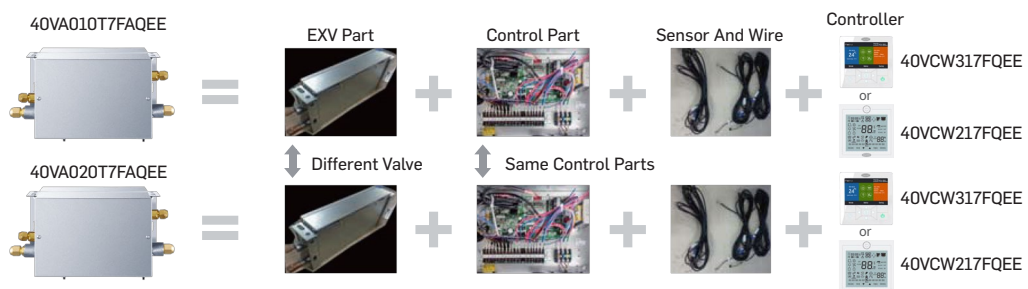

## AHU Connection Kit Control

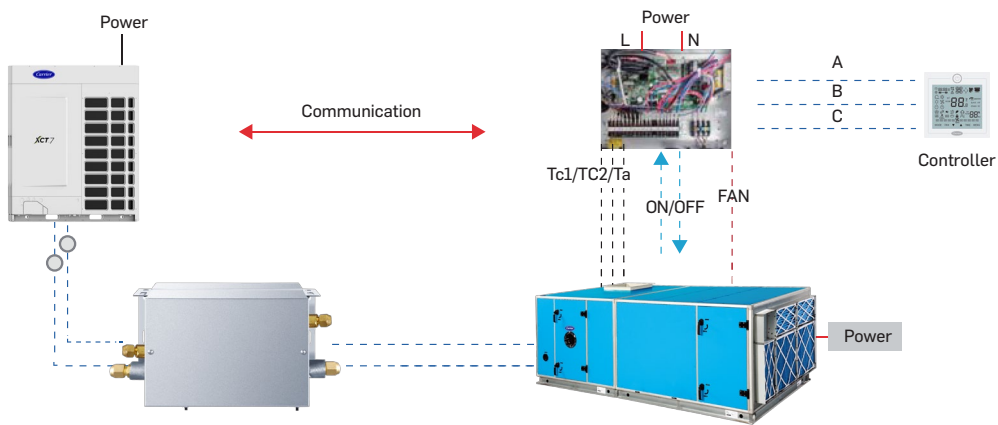

## Specifications (TA control)

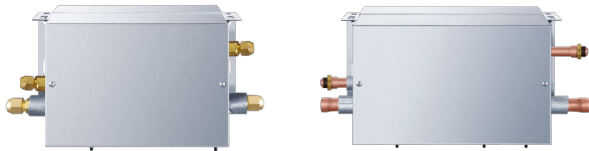

Model	40VA010T7FAQEE	40VA020T7FAQEE
Connected AHU Capacity	14 ≤ x ≤ 28 kW (5-10 HP)	28 < x ≤ 56kW (10-20 HP)
Power Supply (Ph/V/Hz)	1/220-240/50/60	1/220-240/50/60
Dimensions (mm)(L x H x W)	(350 x 226 x 155)	(433 x 296 x 193)
Shipping Dimensions (mm)(L x H x W)	(606 x 295 x 209)	(667 x 365 x 249)
Material	Galvanized steel	Galvanized steel
Weight (kg)	6	8
Shipping Weight (kg)	10	13
Liquid Pipe (mm)	9.52 (Main) / 12.7	12.7 (Main) / 15.88
Gas Pipe (mm)	25.4 (Main) / 22.2 / 19.05	28.58 (Main) / 25.4 / 22.22
Pipe Connection Method	Flare connection and welding	Flare connection and welding
AHU Kit - AHU Coil Max Single Pipe Length (m)	5	5
AHU Kit - AHU Coil Max Height Difference (m)	5	5



AHU Kit



## Air Handling Unit DX Kit (DDC Control)

### System Introduction

Carrier offers a range of connection kits to connect XCT7 outdoor units to 3rd party DX AHU, with DDC control configuration

2 connections are possible:

- Mixed with VRF indoor units, AHU capacity should less than 30% of total capacity
- AHU alone

In both cases (50% < indoor Max connection ratio < 100%)

Compatible to XCT7 top discharge up to 104HP (4 kits) & XCT7 side discharge (4 to 12HP)

Compatible with all XCT7 VRF control solutions

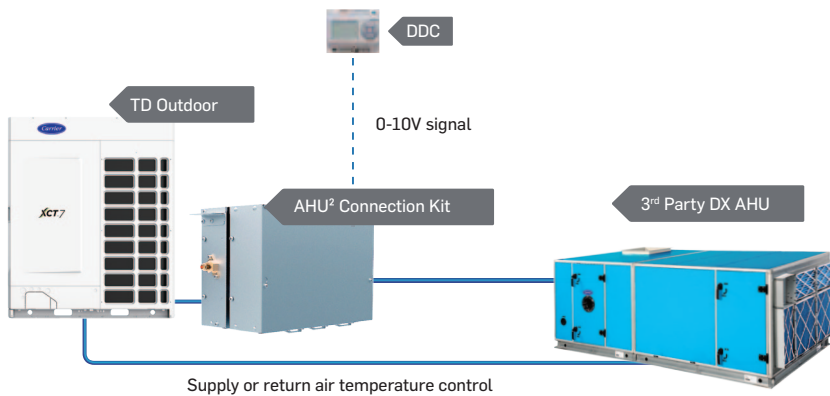

## AHU Kit Configuration

Carrier 2nd generation AHU kit also contains the following 4 parts:

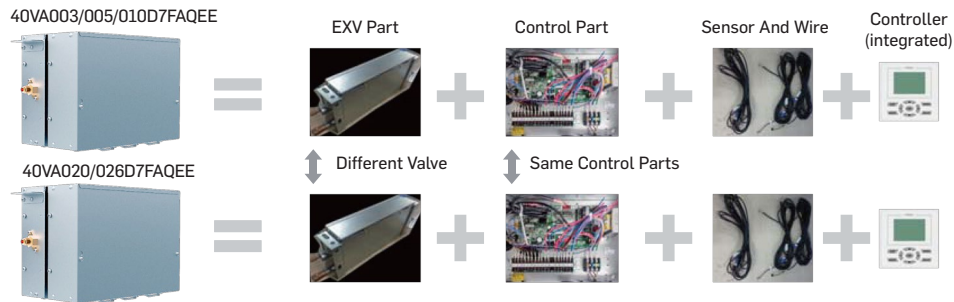

## Control Solutions

Four control methods can be used, which can be switched by dip switch based on the site scenario

### Control solution for application with the 3rd party AHU with DDC controller

- Supply air temperature or return air temperature controllable
- Control AHU by temperature sensors and 0-10 V signal of DDC controller which is supplied locally
- Similar to B control solution, the difference is unproportional 0-10V algorithm for outdoor units capacity control
- Supply air temperature or return air temperature controllable
- Control AHU by temperature sensors and 0-10V signal of DDC controller which are supplied locally
- Similar to A control solution, more accurate temperature control than A

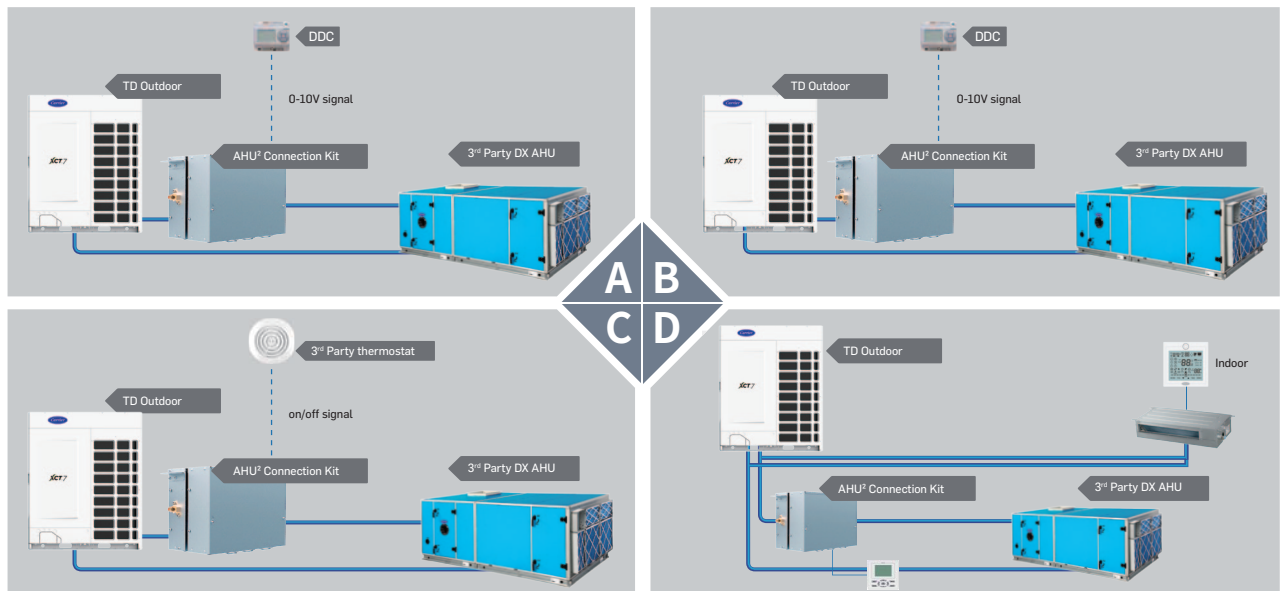

### Control solution for application with 3<sup>rd</sup> party thermostat instead of DDC

- No additional DDC controller required
- Simple and cheap
- Indirect room temperature control

### Control solution for system integrating 3<sup>rd</sup> part AHU with other VRF

- Control the AHU as a VRF indoor units





AHU Kit



## UNIT STRUCTURE

### Features

- Extend the AHU connected capacity per kit, ranging from 3.5 kW to 73 kW, which can meet small, medium and large buildings demands
- Add the 0-10V signal control, for DDC configuration
- Supply air temperature or return air temperature controllable
- Remove the gas pipe, more convenient for installation
- Save space through compact design

### DDC or TA control

40VA\_D7FAQEE

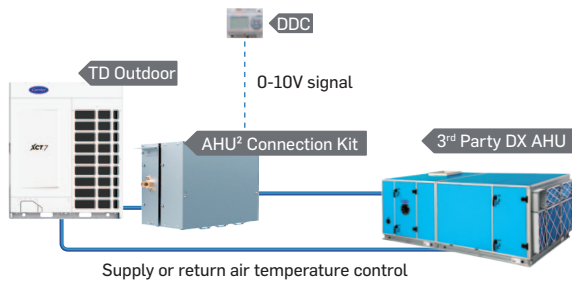

### TA control only

40VA\_T7FAQEE

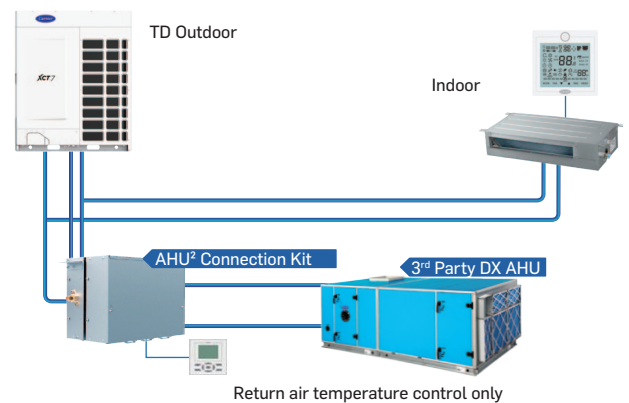

VS





### Specifications (DDC control)



40VA003D7FAQEE  
40VA005D7FAQEE  
40VA010D7FAQEE



40VA020D7FAQEE  
40VA026D7FAQEE

Model	40VA003D7FAQEE	40VA005D7FAQEE	40VA010D7FAQEE	40VA020D7FAQEE	40VA026D7FAQEE
Connected AHU Capacity	$3.5 \leq x \leq 7$ kW (1-3HP)	$7 < x \leq 14$ kW (3-5HP)	$14 \leq x \leq 28$ kW (5-10HP)	$28 < x \leq 56$ kW (10-20HP)	$56 < x \leq 73$ kW (20-26HP)
Power Supply (Ph/V/Hz)	1/220-230/50/60	1/220-230/50/60	1/220-230/50/60	1/220-230/50/60	1/220-230/50/60
Dimensions (mm)(L x H x W)	(420 x 260 x 165)	(420 x 260 x 165)	(420 x 260 x 165)	(420 x 260 x 165)	(420 x 260 x 165)
Shipping Dimensions (mm)(L x H x W)	(520 x 340 x 225)	(520 x 340 x 225)	(520 x 340 x 225)	(520 x 340 x 275)	(520 x 340 x 275)
Material	Galvanized Steel	Galvanized Steel	Galvanized Steel	Galvanized Steel	Galvanized Steel
Color	Grey	Grey	Grey	Grey	Grey
Weight (kg)	5.5	5.5	5.5	6.5	6.5
Shipping Weight (kg)	8	8	8	12	12
Liquid Pipe (mm)	9.52 (Main) / 6.35	9.52 (Main) / 6.35	9.52 (Main) / 6.35	12.7 (Main) / 15.88	12.7 (Main) / 15.88
AHU Kit – Indoor Units Max Single Pipe Length (m)	5	5	5	5	5
AHU Kit – Indoor Units Max Drop (m)	5	5	5	5	5



Turn to the experts









## CONTROLLER

- 135 INDIVIDUAL CONTROLLER
- 137 CENTRALIZED CONTROLLER
- 141 BMS



## Individual Controller Features

Item	Infrared Controller	Wired Controller	Wired Weekly Time Controller	Wired Simple Controller	Remarks
Model	40VCI57FQEE	40VCW217FQEE	40VCW317FQEE	40VCW117FQEE	
picture					
Dimensions (W*H*D) mm	180 x 54.3 x 28	86 x 86 x 13.07	120 x 120 x 17.8	86 x 86 x 15.8	
Power Supply	Battery	12 V AC	12 V AC	12 V AC	
Connectivity	Max. IDUs Controllable	1	16	16	
	Max. Groups Controllable	1	1	1	
Basic Control Function	On/Off	●	●	●	
	Mode Setting (Auto-Heat-Cool-Fan-Dry)	●	●	●	
	Fan Speed Adjustment	●	●	●	
	Temperature Setting	●	●	●	
	Airflow Direction — Up & Down	●	●	●	
	Airflow Direction — Left & Right	●	●	●	Whether the function is available depends on Indoor units.
	Precise Temp. Control	+/-0.5°C	+/-0.5°C	+/-0.5°C	+/-0.5°C
	°F/°C	●	●	●	
Display	Set-point Temp. Display	●	●	●	
	Real Time Clock	●	●	●	/
	Day	/	/	●	/
	IDU Status Display, Including Qty Online, Standby or Running	/	/	●	/
	Backlight	/	●	●	●
Advanced Function	Sleep	●	●	●	/
	Child Lock	/	●	●	●
	Quiet	●	●	●	/
	Turbo	●	●	●	/
	Round-Way Cassette Blade Adjustment	●	●	●	/
	Human Sensor Function	●	●	●	/
	Electric Heater	●	●	●	/
	Control Lock (Under Central Controller)	/	●	●	●
	Temp. Range Limitation (For Energy Saving)	/	●	●	●
	Temp. Compensation	/	●	●	●
	Forced Cooling/Heating	/	●	/	●
	Screen Saving	/	●	●	●
	Screen Brightness Adjustment	/	/	●	/
10°C Heating	●	●	●	/	
Schedule/Timer	Timer On/Off	●	●	●	/
	Weekly Schedule	/	/	●	/
Installer Info.	Forced Defrost	/	●	●	/
	Error Code	/	●	●	●
	Filter Clean Indicator	/	●	●	●
	ESP Grades Adjustment	/	●	●	/
	Installer Setting	/	●	●	/
	Service Help	/	/	●	/
	Password	/	/	●	/
	Parameter Check	/	●	●	●
	Unit No. Setting	/	●	●	●
	Non Volatile Memory (Power Off Memory)	/	●	●	●
Sensor Error Display	/	●	●	●	





● With this function / Without this function

## Centralized Controller & Local BMS Features

Item	Group Controller	Touchscreen Controller	Touchscreen Controller	Local Control	Remote monitoring	
Model	40VCC317FQEE	40VCC727FQEE	40VCC617FQEE	40VCB117FQEE	40VCB217FQEE	
picture						
Dimensions (W*H*D) mm	120 x 120 x 17.8	302.5 x 187.7 x 25	190 x 130 x 20		137.25 x 260.5 x 69.2	
Power Supply	12 V DC	12 V DC	12 V DC	/	AC 110~240	
Connectivity	Max. Controllable IDUs	32	800	256	400	1500
	Max. ODUs System (Max. Gateway Qty)	8	32 x 2	32	32	20 x 4
Screen	Screen Type	TFT LCD	TFT LCD	TFT LCD	/	/
	Screen Dimension	4.3	12.5	7"	/	/
	Button Type	Touch Button	Touch Button	Touch Button	/	/
	Backlight	●	●	●	/	/
	Screen Saver	●	●	●	/	/
	Screen Brightness Adjustment	●	●	●	/	/
Display	Indoor Temperature	●	●	●	●	●
	Clock And Day	●	●	●	●	●
	°C/°F Switch	/	●	●	●	/
Standard Control Function	General IDU Status Statistics Display	/	●	●	/	/
	On/Off	●	●	●	●	●
	Mode (Auto-Cool-Dry-Heat-Fan-Auto)	●	●	●	●	●
	Temperature Setting	●	●	●	●	●
Central Control	Precise Temp. Control 1°C/0.5°C	±1°C	±1°C/±1°F	±1°C	±1°C/±1°F	±1°C/±1°F
	Fan Speed (Auto-Low-Mid-High)	●	●	●	●	●
	Group (Zone) Control	●	●	●	●	●
	One Button For All On/Off	/	●	●	●	●
Shedule	Group (Zone) Name Setting	●	●	●	●	●
	Group (Zone) Name Display	●	●	●	●	●
	Daily	●	●	●	●	●
	Weekly	●	●	●	●	●
Electricity Data Management	Special Day	/	●	●	●	●
	Schedule Programs Qty	16	100	32	No Limit	No Limit
	Electricity Bill	/	/	/	●	●
	Historical Electricity Data	/	/	/	/	●
Advanced Function	Historical Electricity Data Curve	/	/	/	/	●
	Child Lock	●	/	●	/	/
	Control Mode (LIF/Central/Lock)	●	●	●	●	●
	ECO (Set temp. Range Limit)	●	●	●	●	/
	Unit/Groups Setting	●	●	●	●	●
	IDU No. Display	●	●	●	●	●
	Unit Running Time Display	●	/	●	●	●
	Unit Running Curve	/	/	/	/	●
	IDU Parameter Display	●	●	●	●	●
Working Mode (Cool Only/Heat Only/No Limit)	/	●	●	●	●	
HRV Control	Floor Layout (Floor Navigation)	/	●	/	●	●
	HRV ON/OFF	●	/	●	/	/
Installer Info.	HRV Fan (Low Air Exchange-High Air Exchange-Low-High)	●	/	●	/	/
	Password	●	●	●	●	●
	Error Code	●	●	●	●	●
	Error Record Check	●	●	●	●	●
	Parameter Inquiry	●	●	●	●	●
User Account Management	Reset	●	●	●	●	●
	Detailed IDU Parameters Display	/	●	/	●	●
Control Type	User Info.	/	●	/	●	●
	User Account Management Level	/	●	/	●	●
Communication	Local Control Panel	●	●	●	●	●
	PC Version	/	●	/	●	●
	Input	RS-485 1CH	RS-485 5CH	RS-485 1CH	RS-485 1CH	RS-485 4CH
Communication	Output	/	RS-485 1CH	RS-485 1CH	RS-485 1CH	TCP IP
	Fire Alarm Linkage	●	●	●	/	/
Protocol	/	Modbus Rtu	Modbus Rtu	Modbus Rtu	Modbus IP or Bacnet IP	



## Adapters & BMS Gateway Features

Item		Protocol Adapter & Electricity Data	Protocol Adapter	Lonworks™ Gateway	KNX® Gateway	BACnet® Gateway
Model		40VCBM17FQEE	40VCCR17FQEE	40VCBL17FQEE	40VCBK17FQEE 40VCBK27FQEE 40VCBK37FQEE	40VCBB17FQEE
Protocol		Modbus Rtu	Modbus Rtu	Lonworks™	KNX®	BACnet® IP
Picture						
Power Supply		220 V AC	With 12 V DC transformer	24 V DC	29 V DC	AC and DC rated voltage 24 V, working range 12 V to 24 V
Dimensions (W*H*D) mm		200 x 130 x 43	125 x 120 x 40	90 x 70 x 22	70 x 70 x 28	142 x 91 x 35
Communication Port-Input	AC Port (PQ Connection)	1	1			
	RS485			1ch	1ch	2ch
	Pulse Port	1				
Communication Port-Output	RS485	1ch (3rd party Or 40VCB117FQEE, 40VCB217FQEE)	RS485 2ch (for central controller or 3rd party 1ch; for 40VCB117FQEE, 40VCB217FQEE)			
	RS485 For Lonworks Protocol Device			1ch		
	Bacnet IP					1
	KNX				KNX port plug-in terminal block(2 poles)	
Operation Temp.		-30-52°C	-20-70°C	-20-70°C	0-60°C	-20-70°C
Stock Temp.		-30-52°C	-40-85°C	-40-85°C	-20-85°C	-40-85°C
Operational Humidity		10%-85%	5-90% (non-condensing)	5-90% (non-condensing)	<90%,RH, non-condensing	5-90% (non-condensing)
Stock Humidity		10%-85%	5-95% (non-condensing)	5-95% (non-condensing)	<90%,RH, non-condensing	5-95% (non-condensing)
Function Description		Embedded in TD ODU Converter homebus to Modbus And Electricity collection and distribution function must connect this adapter.	Converter homebus to Modbus For SD ODU	For SD ODU Works with 40VCCR17FQEE to converter Modbus to Lonworks™	For SD ODU Works with 40VCCR17FQEE to converter Modbus to KNX®	For SD ODU Works with 40VCCR17FQEE to converter Modbus to BACnet® IP





Turn to the experts

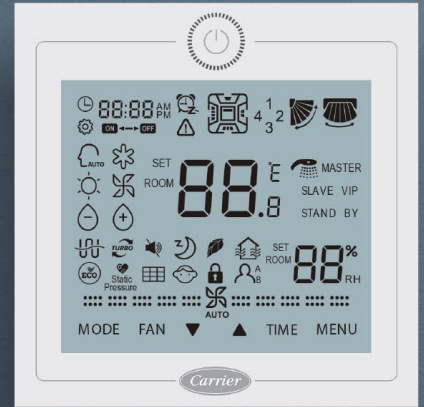

Controller



## INDIVIDUAL CONTROLLER



### 40VCI57FQEE Wireless Remote Controller

- Basic function: on/off mode, 5 fan speed, temperature setting, swing
- Individual louver control for round-way cassette
- Clock & timer
- Follow/evade function (optional)
- Celsius to fahrenheit selection
- As an option except for Highwall



### 40VCW117FQEE Simple Wired Controller

- Basic function: on/off mode, 3 fan speed, temperature
- Individual & group controller (max 16 indoor units)
- Simple and smart design, 86\*86\*15.80mm



### 40VCIR7FQEE Infrared Receiver

- For duct units



### 40VCW217FQEE Standard Wired Controller

- Basic function: on/off mode, 5 fan speed, temperature setting, swing
- Individual & group control (max. 16 indoor units)
- Simple and smart design, 86\*86\*13.05 mm
- Touch button with back light
- Timer/clock
- Easy installation



### 40VCW317FQEE Wired Weekly Timer

- Colorful screen: 120mm X 120mm X 17.8 mm
- Basic function: on/off mode, fan speed, temperature setting, swing
- Individual & group control (max. 16 indoor units)
- Fahrenheit/ Celsius selectable; sensitivity  $\pm 0.5^{\circ}\text{C}$
- Weekly timer
- Individual louver control for round-way cassette
- Static pressure setting





Turn to the experts

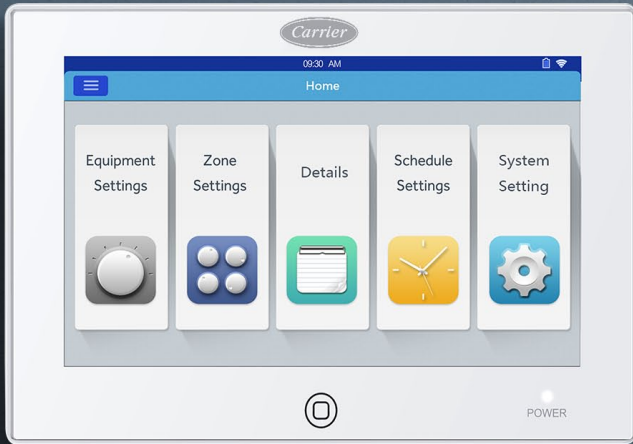

Controller



## CENTRALIZED CONTROLLER



### 40VCC317FQEE Simple Group Controller

- Individual control, group control & central control (max. 32 indoor units)
- Large touch key
- Weekly timer
- Unit name & group name free setting, four backgrounds available (mall, hotel, office, home)
- Error display
- Must be used in combination with an adapter 40VCCR17FQEE for side discharge ODU



### 40VCC617FQEE Touchscreen Controller

- Individual control, group control & central control (Max. 256 indoor units)
- 7 inch TFT LCD touch screen with back light
- Weekly timer
- Indoor units' information editable
- Error display
- XCT7 Top Discharge system can connect directly; other Side Discharge systems require 40VCCR17FQEE



Controller

## 40VCC617FQEE System

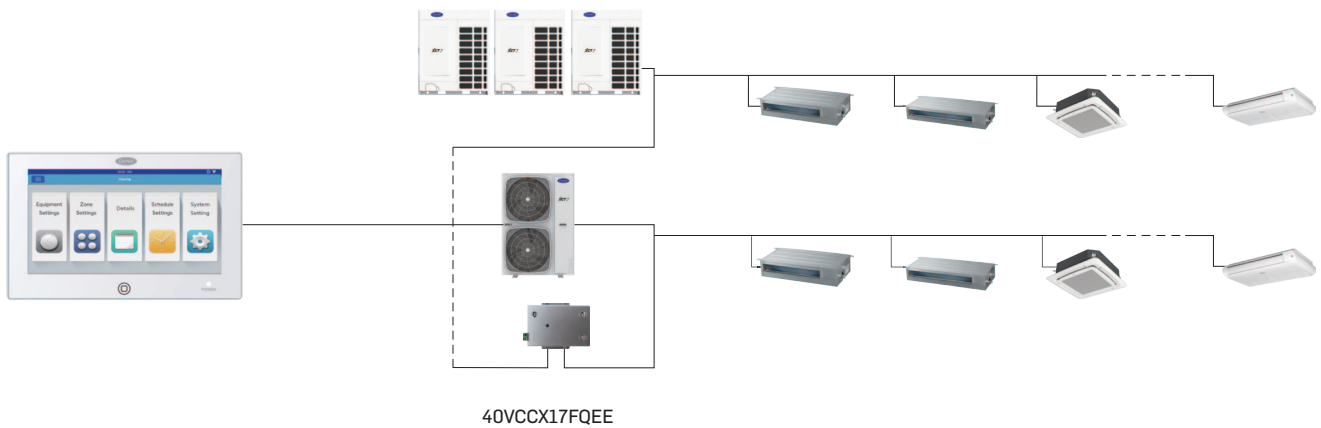



Turn to the experts



Controller



## CENTRALIZED CONTROLLER



### 40VCC727FQEE Touchscreen Controller

- Individual control, group control & central control (Max 800 indoor units)
- 12.5 inch TFT LCD touch screen
- Web access & e-mail alarm
- Weekly schedule & special day setting
- Floor plan layout view
- Can integrate 3<sup>rd</sup> party devices like fire alarm, fan, lighting, other than XCT7 indoor units
- \* Must be used in combination with a 40VCCX17FQEE for each XCT7 system (Max. 64 indoor units)





Controller

## 40VCC727FQEE

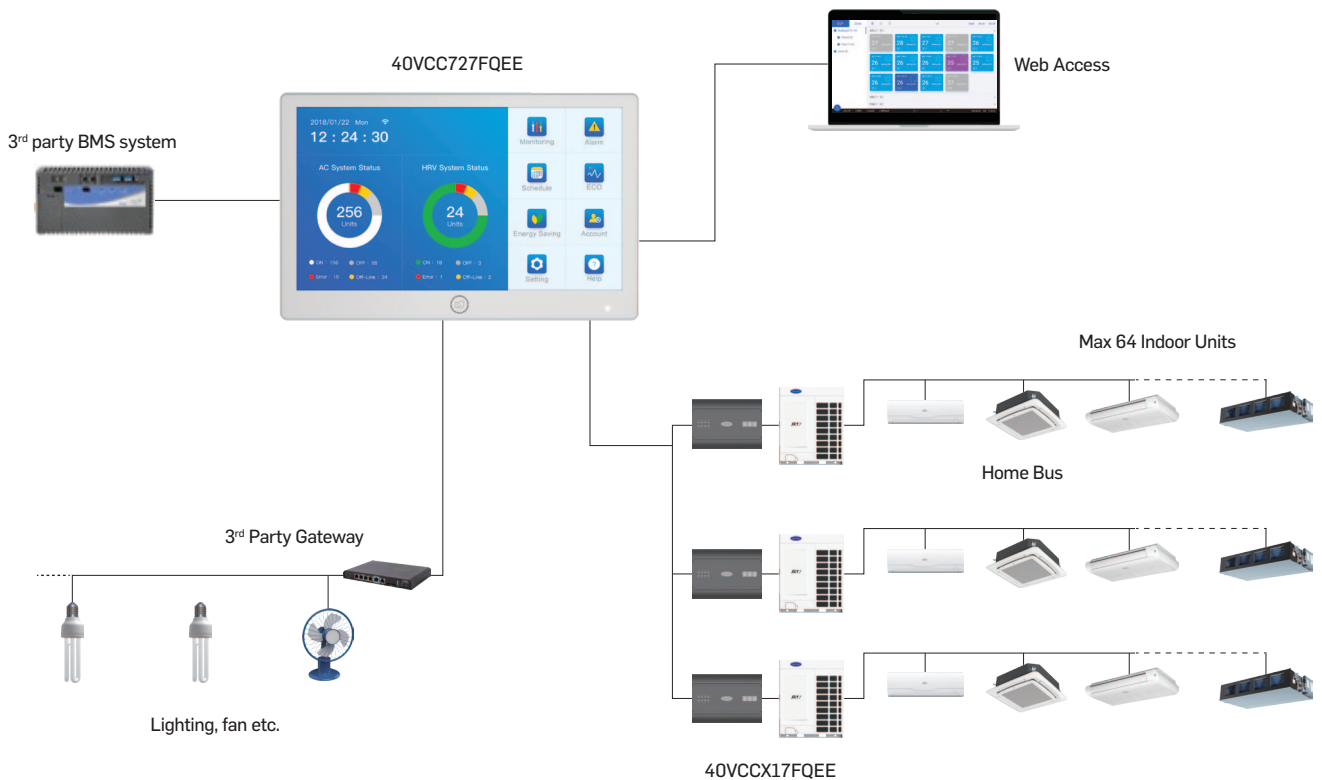





Controller

BMS

## BMS - LOCAL CONTROL



### 40VCB117FQEE

- Local version or PC version; Convert RS-485 to USB
- Max. 400 indoor units can be controlled
- ModBus RTU interface, also supports 3rd party interface
- Win 7 32bits/64bits, Win 8 Pro, Win 10 Pro
- Max. 32 systems
- Each Side Discharge system requires one 40VCCR17FQEE
- Schedule setting
- Power consumption report (must use 40VCBM17FQEE)
- Data monitoring & control function

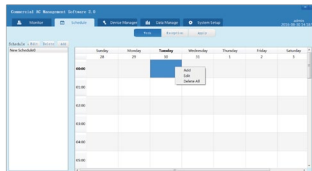

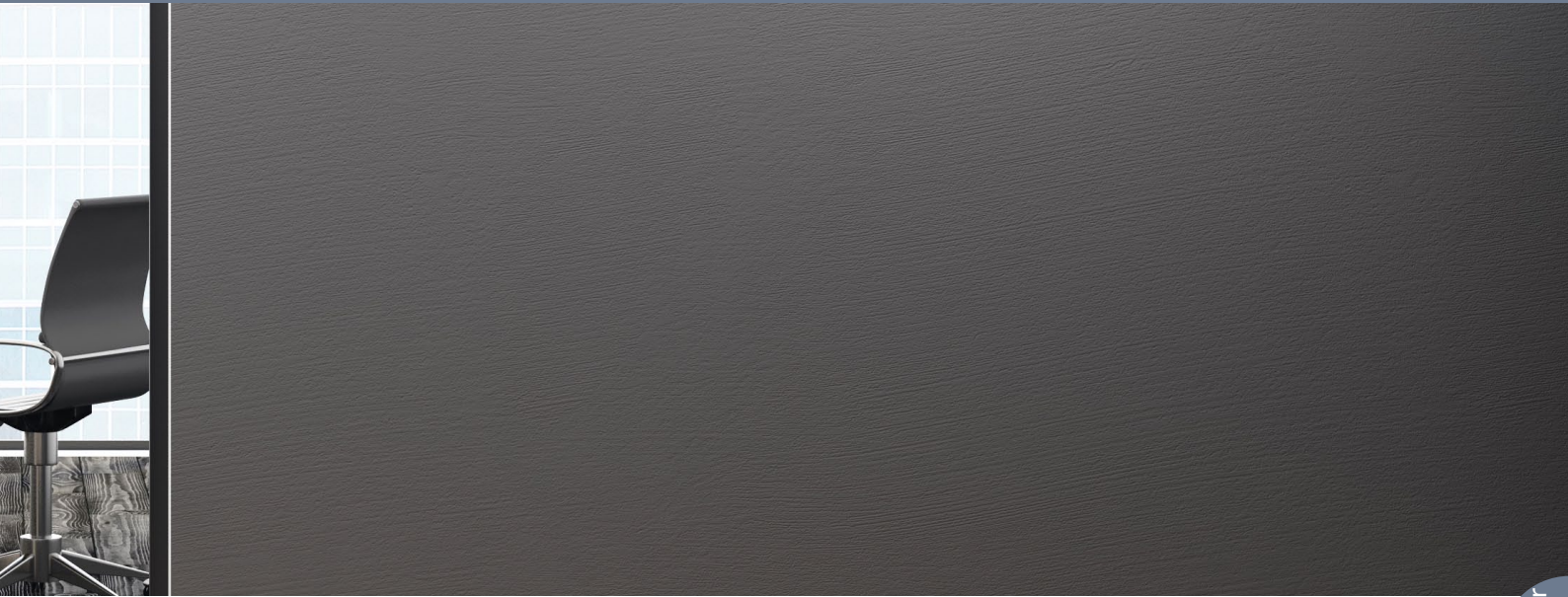

### 40VCB117FQEE System

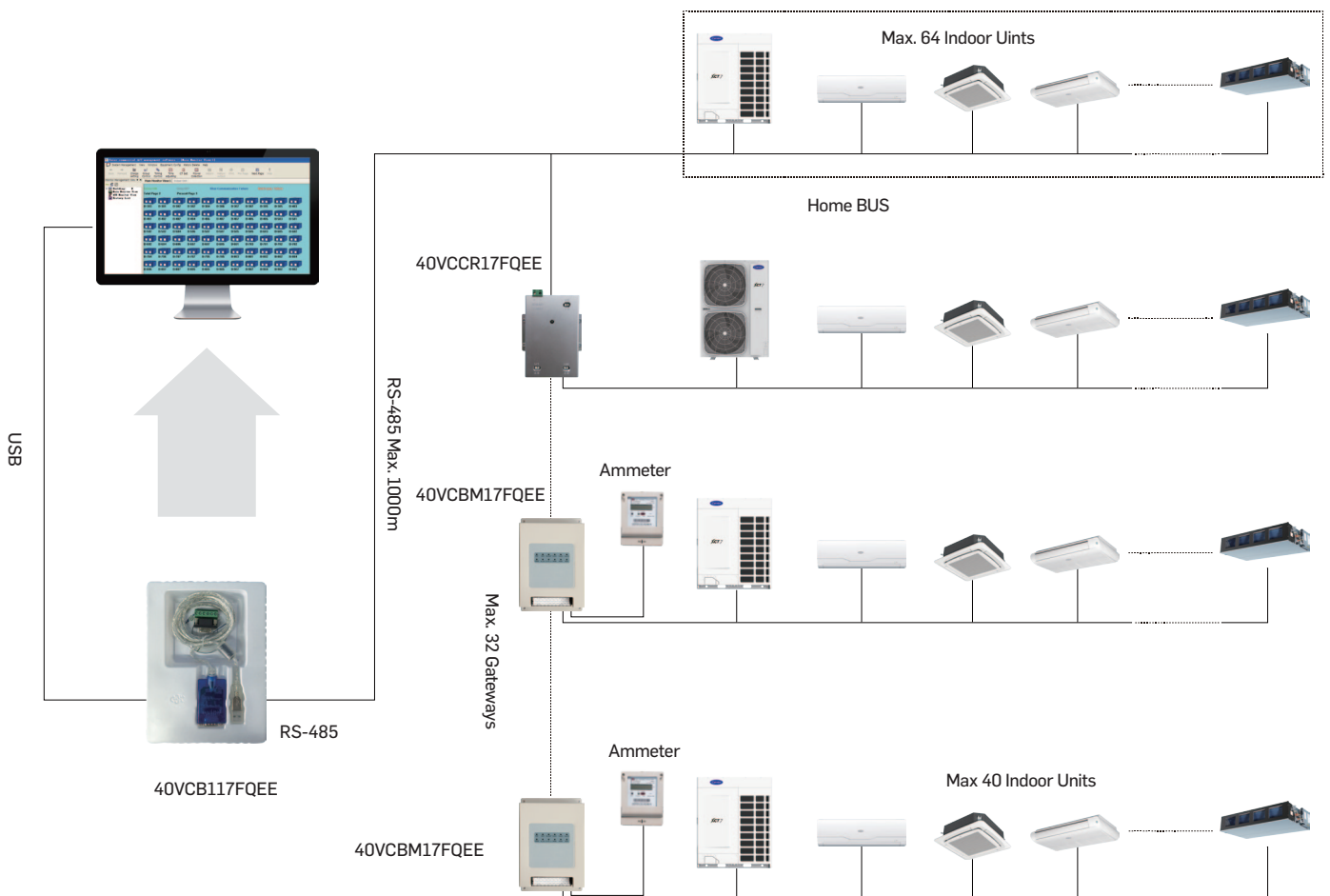



BMS

## BMS - REMOTE MONITORING



### 40VCB217FQEE

- Remote monitoring version supports also third party interface: BACnet ip/Modbus ip/Modbus RTU
- Max. 1500 indoor units can be controlled
- Max. 4 groups. each group can connect 20 systems. If Top Discharge outdoor units, additional adapter is not required. If Side Discharge outdoor units, 40VCCR17FQEE is needed.
- Operation status setting & monitoring
- Schedule setting
- Multi-user management with different authorized levels
- Operation and error history log
- Web interface access
- Power consumption data & report only available if using 40VCBM17FQEE + Ammeter

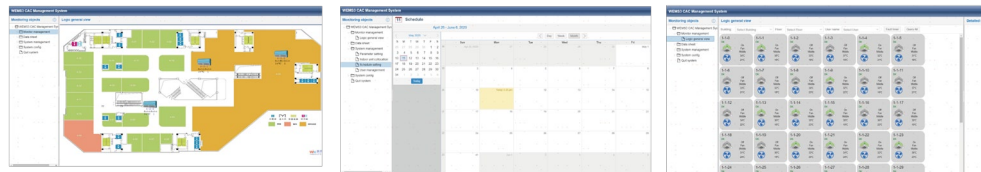





### 40VCB217FQEE System

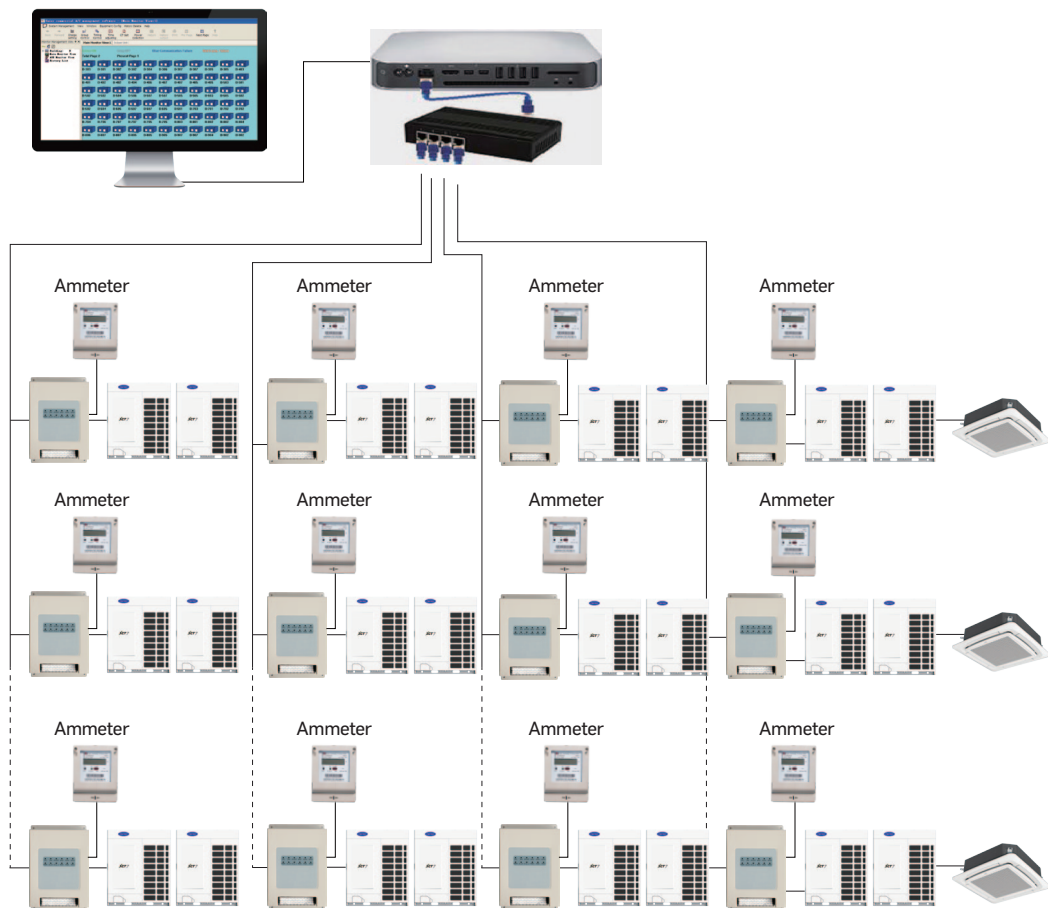

40VCBM17FQEE





Controller

BMS

## BMS GATEWAYS



### 40VCBL17FQEE

- 40VCBL17FQEE, convert ModBus RTU to Lonworks™
- Each system requires one adapter 40VCBL17FQEE (combine with 40VCCR17FQEE if outdoor unit is XCT7)
- Max. 32 indoor units can be connected in one system
- External 24 V DC power supply is needed



### 40VCBB17FQEE

- Protocol adapter, convert Modbus RTU to BACNET® Gateway
- Max. 128 indoor units/ 4 systems can be controlled
- Operation status setting & monitoring
- Schedule setting
- Multi-user management
- 40VCCR17FQEE is required for Side Discharge outdoor units



## LonWorks System

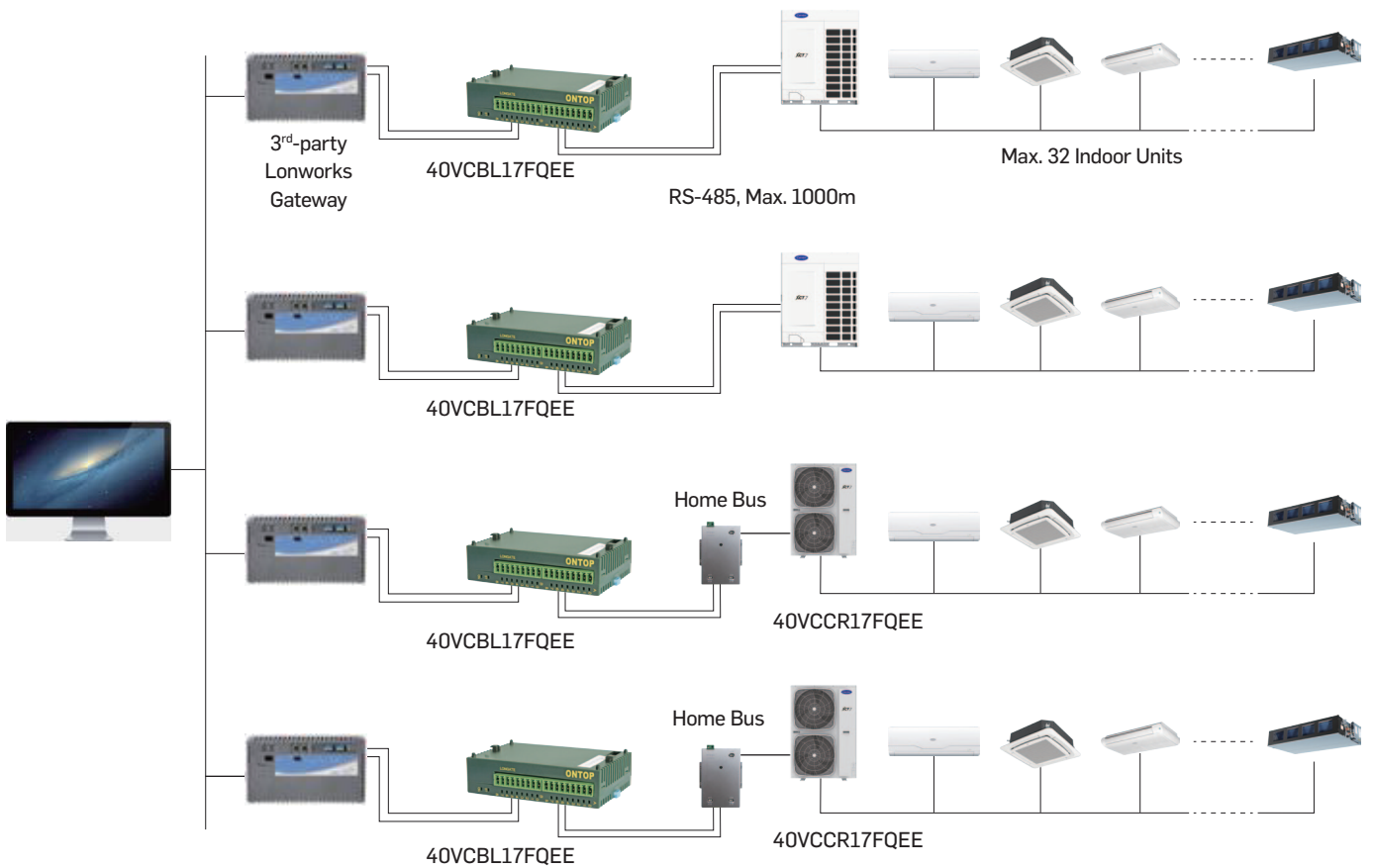



Controller

BMS

## BMS PROTOCOL ADAPTERS



40VCBK17FQEE(8 IDU)    40VCBK27FQEE(16 IDU)  
40VCBK37FQEE(64 IDU)

- KNX® gateway
- Convert modbus rtu to KNX®
- Each side discharge ODU requires one KNX® gateway + 40VCCR17FQEE
- Max.8/16/64 indoor units can be connected in one system



40VCCR17FQEE

- Protocol adapter, convert home bus to RS-485
- Gateway: ModBus RTU
- Max. 64 indoor units can be connected with one 40VCCR17FQEE
- Side discharge XCT7 requires one 40VCCR17FQEE when connecting with centralized controller or BMS system

Modbus model No.	No. of I.U. controllable	Installation Method	Compatible O.U. Type
40VCCR17FQEE	64	Outside the O.U.	Side and Top discharge O.U.



40VCBM17FQEE

- Protocol adapter, convert home bus to ModBus
- Power consumption data collection, and storage (requires 3rd party ammeter)
- Match with local BMS (40VCB117FQEE,40VCB217FQEE), each system requires one adapter
- Max. 40 indoor units can be connected with one 40VCBM17FQEE Gateway



### Controllers Match Table for Indoor Units

Outlook	Series	 40VCI57FQEE	 40VCW217FQEE	 40VCW317FQEE	 40VCW117FQEE
	ONE-WAY CASSETTE	●	●	●	●
	TWO-WAY CASSETTE	●	●	●	●
	COMPACT FOUR-WAY CASSETTE	●	●	●	●
	ROUND-WAY CASSETTE	●	●	●	●
	SLIM DUCT	●	●	●	●
	STANDARD STATIC DUCT 20/200 Pa	●	●	●	●
	HIGH STATIC DUCT 0/200 Pa	●	●	●	●
	HIGH WALL	●	●	●	●
	TWO-WAY CONSOLE	●	●	●	●
	CONSOLE-RECESSED	●	●	●	●
	FLEX CEILING FLOOR AC	●	●	●	●
	FLEX CEILING FLOOR DC	●	●	●	●

Controller

● Controllers match with the indoor unit





Turn to the experts



# Control Systems

3rd Party BMS or HEMS

Central Control



Web Access



40VCC617FQEE

40VCC317FQEE



40VCC727FQEE

40VCC117FQEE



BACnet® IP/Modbus IP  
40VCB217FQEE

40VCB117FQEE



3rd Party Integrator Program

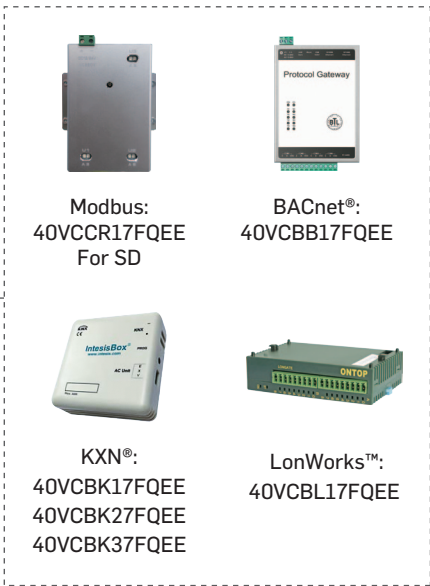

Modbus:  
40VCCR17FQEE  
For SD

BACnet®:  
40VCBB17FQEE



KXN®:  
40VCBK17FQEE  
40VCBK27FQEE  
40VCBK37FQEE



LonWorks™:  
40VCBL17FQEE

Controller

## Individual Control



40VCI57FQEE

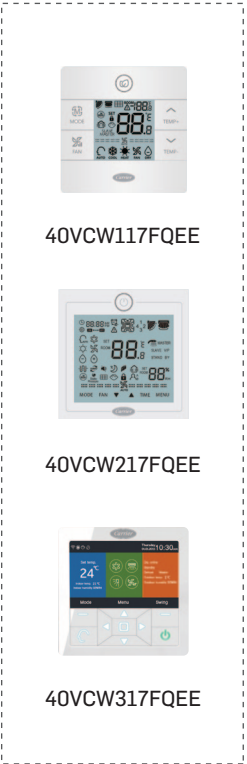
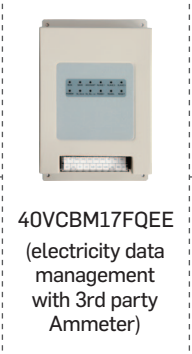
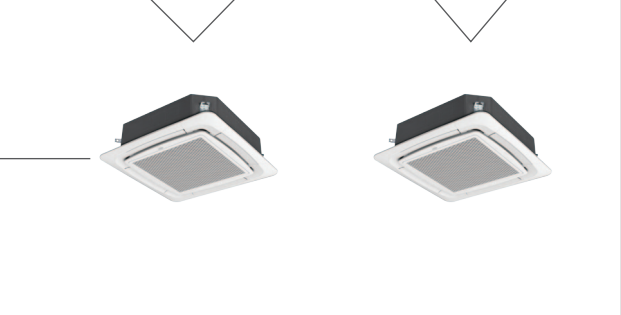
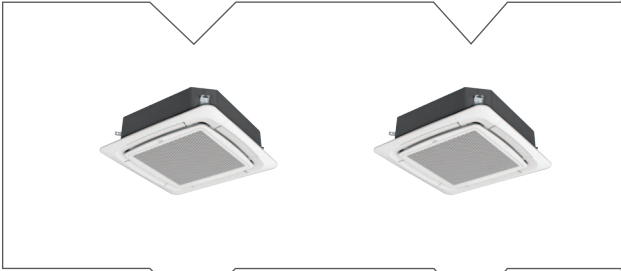
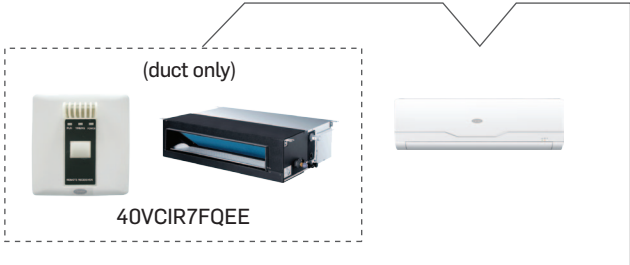

Controller



Turn to the experts

# Softwares



Software

## Carrier Service Tool- Easy to Monitor Your System

Installers and contractors will appreciate the Carrier service tool to monitor the XCT7 VRF systems operation data. Thanks to the 40VCTOOLQEE interface accessory, you can retrieve the VRF system information from the Outdoor Unit. You can then read the running parameters on your computer and analyze them for troubleshooting in the field or save the data for further analysis.



40VCTOOLQEE

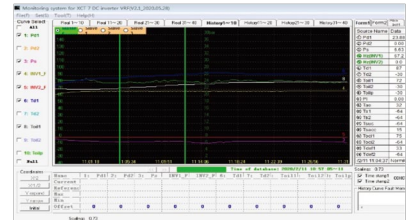
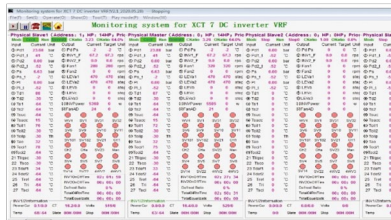

Service, Support & Product Training

## Customer Focus

As your preferred partner, Carrier designs tailored Service programs to meet your goals and optimize your business performance.

## Proximity & Responsiveness

Carrier expert technicians are there to take action, quickly. The comprehensive and highly efficient maintenance processes mean your equipment will soon be back in action.

## Expertise & Consultancy

Your Carrier experts can help you find the right balance between energy efficiency and your investment's optimization with our wide choice of technologies and solutions. Thanks to the expertise of our internal team, we are able to offer the highest level of consultancy.







Turn to the experts



## ACCESSORIES

- 154 HEAT PUMP - ODU PIPING CONNECTION ACCESSORIES
- 155 HEAT PUMP - IDU PIPING CONNECTION ACCESSORIES
- 157 HEAT RECOVERY – ODU PIPING CONNECTION ACCESSORIES
- 161 HEAT RECOVERY – IDU PIPING CONNECTION ACCESSORIES
- 163 HEAT RECOVERY – VALVE BOX







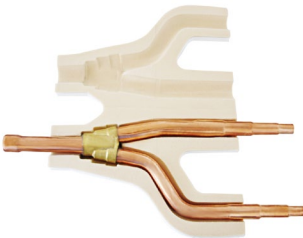
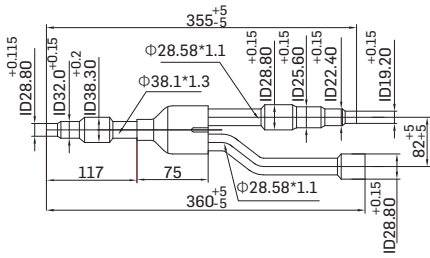
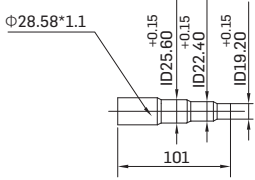
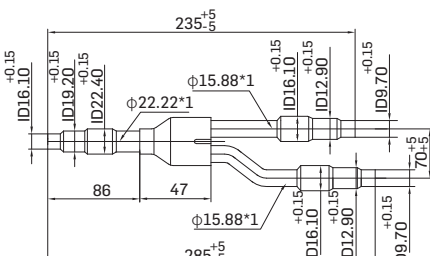
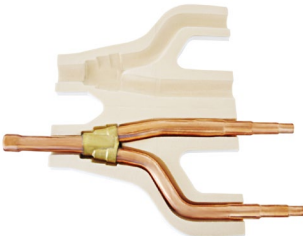
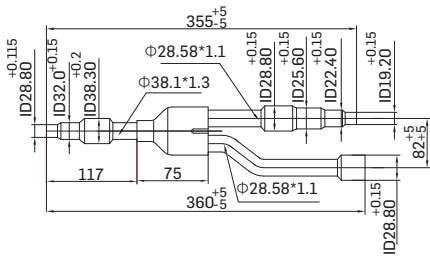
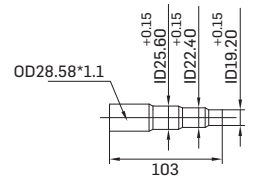
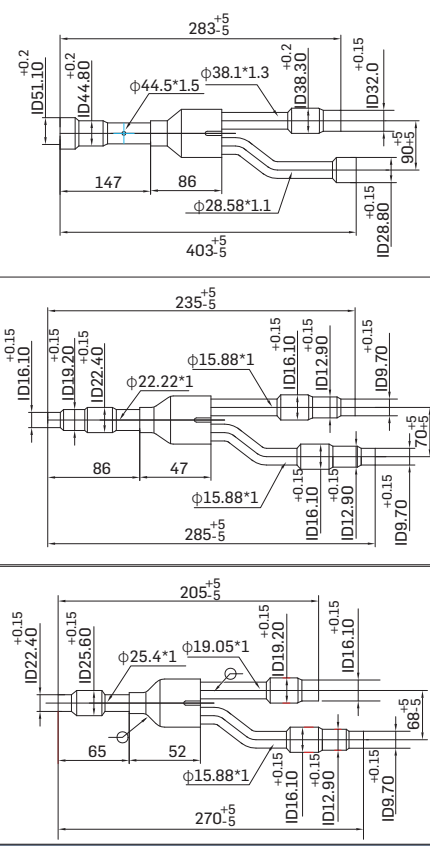
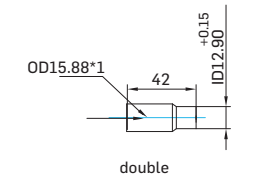

## Accessories

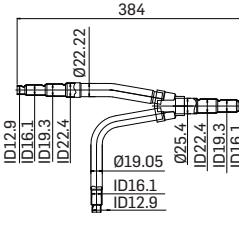
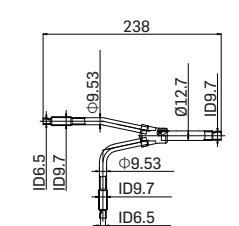
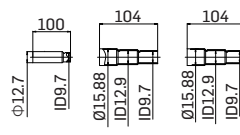
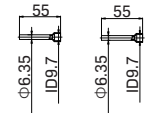
Shape	Model	Description
Piping accessory for Heat Pump outdoor unit combination connection		
	40VJ052G7-HQEE	For two outdoor units combination at installation location
	40VJ078G7-HQEE	For three outdoor units combination at installation location
	40VJ078G7-HQEE +40VJ072M7-HQEE	For four outdoor units combination at installation location
Piping accessory for Indoor unit and Heat pump outdoor unit connection		
	40VJ012M7-HQEE	< 33.5 kW
	40VJ018M7-HQEE	33.5 < < 50.6kW
	40VJ026M7-HQEE	50.6 < < 73kW
	40VJ048M7-HQEE	73 < < 135kW
	40VJ072M7-HQEE	135 < < 204kW

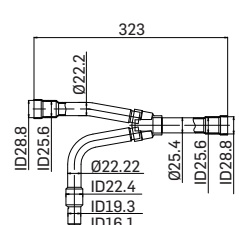
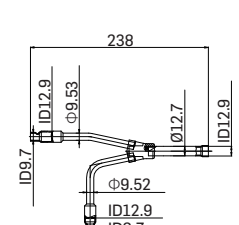
Piping accessory for Heat Pump outdoor unit combination connection

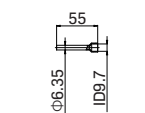
Model Name	Side	Gather Pipe	Connection of Gather Pipe
<p>40VJ052G7-HQEE</p> 	Suction gas side		
	Liquid side		
<p>40VJ078G7-HQEE</p> 	Suction gas side		 <p>double</p>
	Liquid side		 <p>double</p>

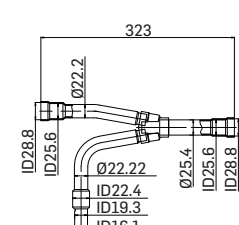
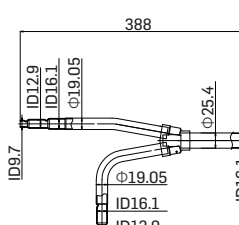
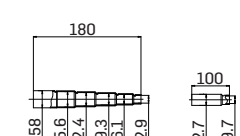
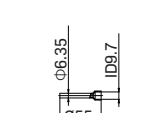
Piping accessory for Indoor unit and Heat pump outdoor unit connection

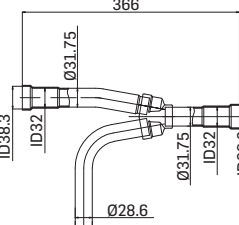
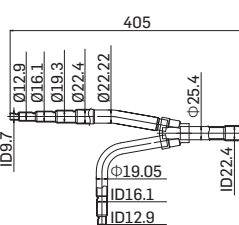
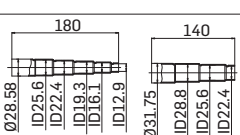
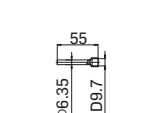
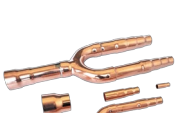
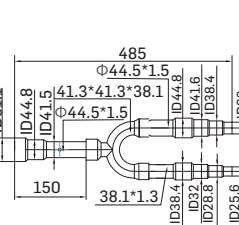
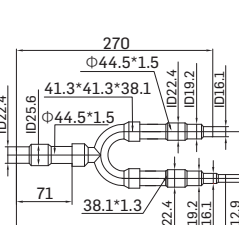
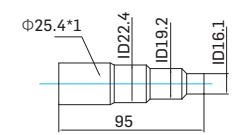
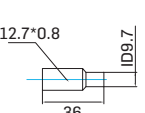
Model	Gas Side Branch Pipe	Liquid Side Branch Pipe	Gas Side Connection of Branch Pipe	Liquid Side Connection of Branch Pipe
<p>40VJ012M7-HQEE</p> 	 <p>384</p> <p>Ø22.22</p> <p>ID12.9 ID16.1 ID19.3 ID22.4</p> <p>Ø19.05</p> <p>Ø25.4</p> <p>ID22.4 ID19.3 ID16.1 ID12.9</p>	 <p>238</p> <p>Ø9.53</p> <p>Ø12.7</p> <p>ID9.7</p> <p>Ø9.53</p> <p>ID9.7</p> <p>ID6.5</p>	 <p>100</p> <p>104</p> <p>104</p> <p>Φ12.7 ID9.7</p> <p>Ø15.88 ID12.9 ID9.7</p> <p>Ø15.88 ID12.9 ID9.7</p>	 <p>55</p> <p>55</p> <p>Φ6.35 ID9.7</p> <p>Φ6.35 ID9.7</p>
<p>40VJ018M7-HQEE</p> 	 <p>323</p> <p>Ø22.2</p> <p>ID28.8 ID25.6</p> <p>Ø22.22</p> <p>ID22.4</p> <p>Ø25.4</p> <p>ID25.6 ID28.8</p> <p>ID19.3 ID16.1 ID12.9</p>	 <p>238</p> <p>ID12.9</p> <p>Ø9.53</p> <p>Ø12.7</p> <p>ID9.7</p> <p>Ø9.52</p> <p>ID12.9 ID9.7 ID6.5</p>	 <p>180</p> <p>100</p> <p>Ø28.58 ID25.6 ID22.4 ID19.3 ID16.1 ID12.9</p> <p>Φ12.7 ID9.7</p>	 <p>55</p> <p>Φ6.35 ID9.7</p>
<p>40VJ026M7-HQEE</p> 	 <p>323</p> <p>Ø22.2</p> <p>ID28.8 ID25.6</p> <p>Ø22.22</p> <p>ID22.4</p> <p>Ø25.4</p> <p>ID25.6 ID28.8</p> <p>ID19.3 ID16.1 ID12.9</p>	 <p>388</p> <p>ID12.9 ID16.1</p> <p>Φ19.05</p> <p>Ø25.4</p> <p>ID9.7</p> <p>Φ19.05</p> <p>ID16.1 ID12.9 ID9.7 ID6.5</p> <p>ID16.1</p>	 <p>180</p> <p>100</p> <p>Ø28.58 ID25.6 ID22.4 ID19.3 ID16.1 ID12.9</p> <p>Φ12.7 ID9.7</p>	 <p>55</p> <p>Φ6.35 ID9.7</p>
<p>40VJ048M7-HQEE</p> 	 <p>366</p> <p>Ø31.75</p> <p>ID38.3 ID32</p> <p>Ø28.6</p> <p>Ø31.75</p> <p>ID32 ID38.3</p> <p>ID28.8</p>	 <p>405</p> <p>Ø12.9 Ø16.1 Ø19.3 Ø22.4</p> <p>Ø25.4</p> <p>ID9.7</p> <p>Ø19.05</p> <p>ID16.1 ID12.9 ID9.7 ID6.5</p> <p>ID22.4 ID19.3</p>	 <p>180</p> <p>140</p> <p>138</p> <p>100</p> <p>Ø28.58 ID25.6 ID22.4 ID19.3 ID16.1 ID12.9</p> <p>Ø31.75 ID28.8 ID25.6 ID22.4</p> <p>Φ12.7 ID9.7</p> <p>ID35.1 ID49</p> <p>Φ38.1</p>	 <p>55</p> <p>Φ6.35 ID9.7</p>
<p>40VJ072M7-HQEE</p> 	 <p>485</p> <p>Φ44.5*1.5</p> <p>41.3*41.3*38.1</p> <p>Φ44.5*1.5</p> <p>ID51.1 ID44.8 ID41.5</p> <p>150</p> <p>38.1*1.3</p> <p>ID38.4 ID32 ID28.8 ID25.6</p> <p>130</p>	 <p>270</p> <p>Φ44.5*1.5</p> <p>41.3*41.3*38.1</p> <p>Φ44.5*1.5</p> <p>ID25.6</p> <p>71</p> <p>38.1*1.3</p> <p>ID22.4 ID19.2 ID16.1</p> <p>70</p> <p>ID19.2 ID16.1 ID12.9</p> <p>290</p>	 <p>Φ25.4*1</p> <p>ID22.4</p> <p>ID19.2</p> <p>ID16.1</p> <p>95</p> <p>Φ44.5*1.5</p> <p>ID51.1</p> <p>62</p>	 <p>Φ12.7*0.8</p> <p>36</p> <p>ID9.7</p>





	Side	Mark	Manifold Pipe	Insulation Material
40VJ066G7-RQEE	Suction gas side	D		
		E		
	HP gas side	F		
		G		
	Liquid side	H		
		I		

Piping accessory for Heat Recovery outdoor unit combination connection

68-88 HP

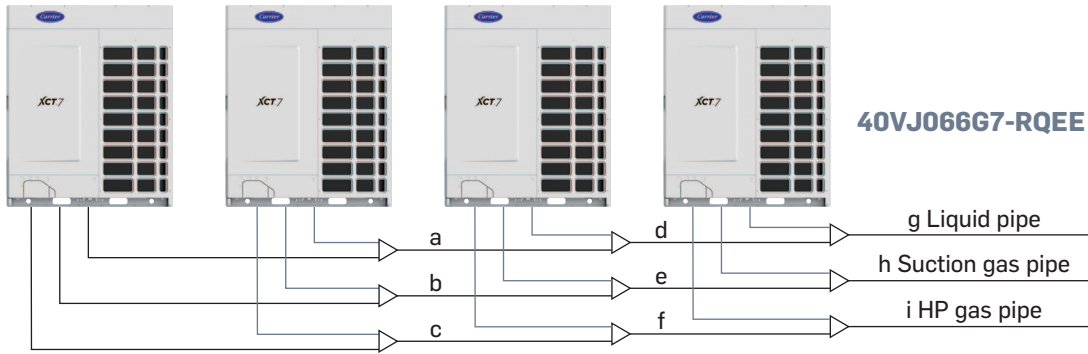









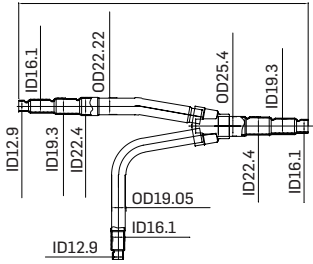
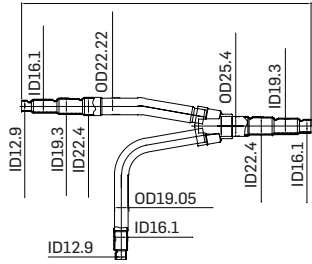
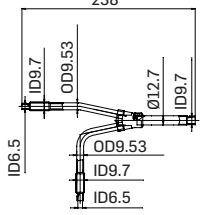

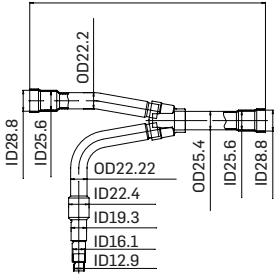
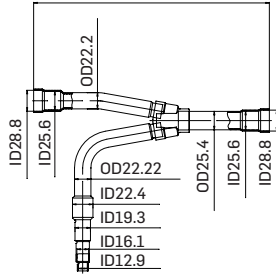
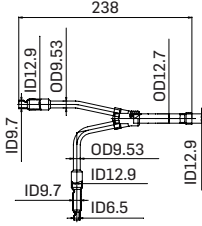

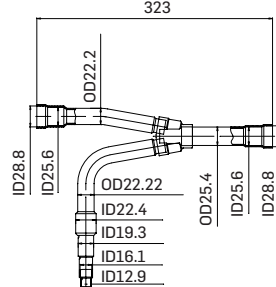
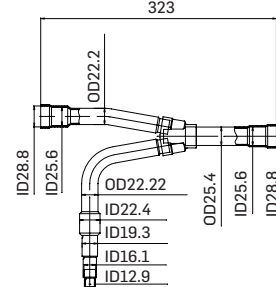
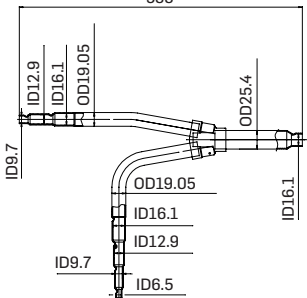

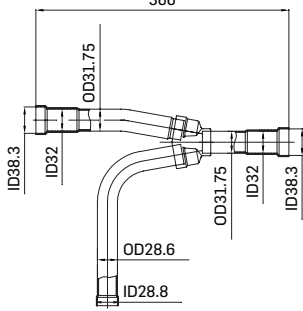
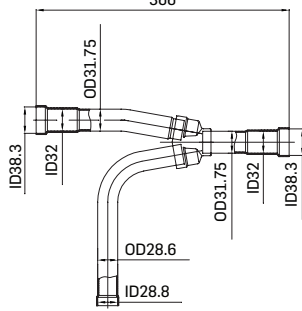
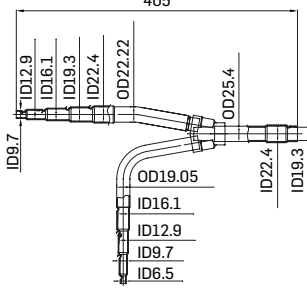

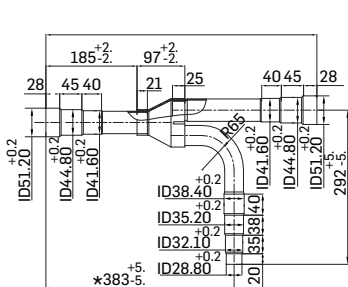
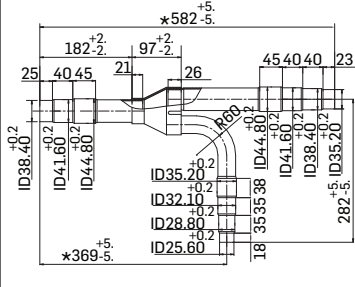
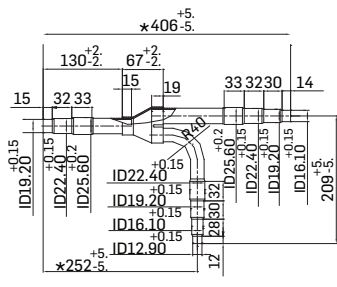

	Side	Mark	Manifold Pipe	Insulation Material
40VJ088G7-RQEE	Liquid side	P		
		Q		
		R		

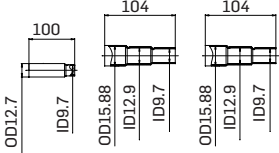
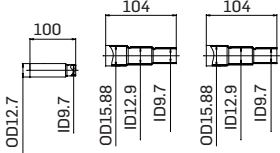
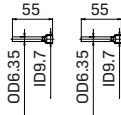
	Side	Mark	Manifold Pipe	Insulation Material
40VJ088G7-RQEE	Suction gas side	J		
		K		
		L		
40VJ088G7-RQEE	HP gas side	M		
		N		
		O		

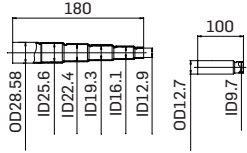
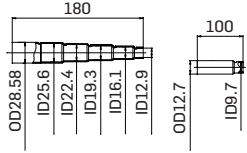
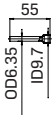

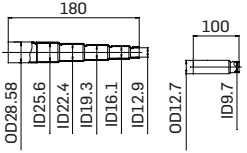
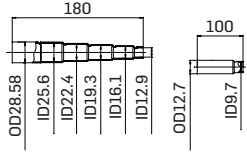
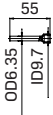
Piping accessory for Indoor unit and Heat Recovery outdoor unit connection

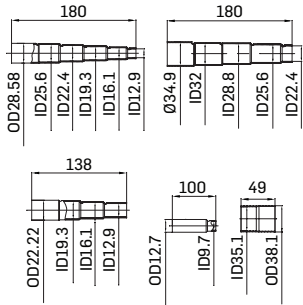
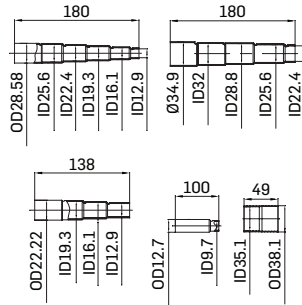
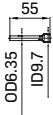
Model	Suction Gas Branch Pipe	HP Gas Branch Pipe	Liquid Branch Pipe
<p>40VJ012M7-RQEE</p> 	<p>384</p> 	<p>384</p> 	<p>238</p> 
<p>40VJ018M7-RQEE</p> 	<p>323</p> 	<p>323</p> 	<p>238</p> 
<p>40VJ026M7-RQEE</p> 	<p>323</p> 	<p>323</p> 	<p>388</p> 
<p>40VJ048M7-RQEE</p> 	<p>366</p> 	<p>366</p> 	<p>405</p> 
<p>40VJ072M7-RQEE</p> 			

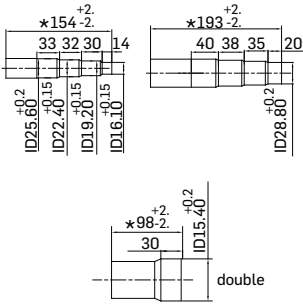
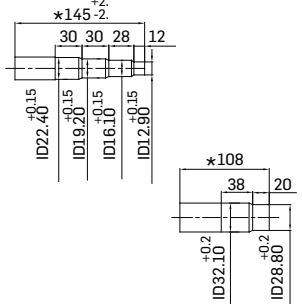
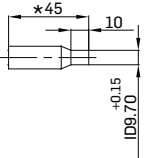
Model	Suction Gas Branch Pipe	HP Gas Branch Pipe	Liquid Branch Pipe
<p>40VJ012M7-RQEE</p> 	 <p>Dimensions: 100, 104, 104            OD12.7, ID9.7, OD15.88, ID12.9, ID9.7, OD15.88, ID12.9, ID9.7</p>	 <p>Dimensions: 100, 104, 104            OD12.7, ID9.7, OD15.88, ID12.9, ID9.7, OD15.88, ID12.9, ID9.7</p>	 <p>Dimensions: 55, 55            OD6.35, ID9.7, OD6.35, ID9.7</p>
<p>40VJ018M7-RQEE</p> 	 <p>Dimensions: 180, 100            OD28.58, ID25.6, ID22.4, ID19.3, ID16.1, ID12.9, OD12.7, ID9.7</p>	 <p>Dimensions: 180, 100            OD28.58, ID25.6, ID22.4, ID19.3, ID16.1, ID12.9, OD12.7, ID9.7</p>	 <p>Dimensions: 55            OD6.35, ID9.7</p>
<p>40VJ026M7-RQEE</p> 	 <p>Dimensions: 180, 100            OD28.58, ID25.6, ID22.4, ID19.3, ID16.1, ID12.9, OD12.7, ID9.7</p>	 <p>Dimensions: 180, 100            OD28.58, ID25.6, ID22.4, ID19.3, ID16.1, ID12.9, OD12.7, ID9.7</p>	 <p>Dimensions: 55            OD6.35, ID9.7</p>
<p>40VJ048M7-RQEE</p> 	 <p>Dimensions: 180, 180, 138, 100, 49            OD28.58, ID25.6, ID22.4, ID19.3, ID16.1, ID12.9, Ø34.9, ID32, ID28.8, ID25.6, ID22.4, OD22.22, ID19.3, ID16.1, ID12.9, OD12.7, ID9.7, ID35.1, OD38.1</p>	 <p>Dimensions: 180, 180, 138, 100, 49            OD28.58, ID25.6, ID22.4, ID19.3, ID16.1, ID12.9, Ø34.9, ID32, ID28.8, ID25.6, ID22.4, OD22.22, ID19.3, ID16.1, ID12.9, OD12.7, ID9.7, ID35.1, OD38.1</p>	 <p>Dimensions: 55            OD6.35, ID9.7</p>
<p>40VJ072M7-RQEE</p> 	 <p>Dimensions: *154, 33, 32, 30, 14, *193, 40, 38, 35, 20, ID25.60, ID22.40, ID19.20, ID16.10, ID12.90, ID28.80, *98, 30, ID15.40, double</p>	 <p>Dimensions: *145, 30, 30, 28, 12, *108, 38, 20, ID22.40, ID19.20, ID16.10, ID12.90, ID32.10, ID28.80</p>	 <p>Dimensions: *45, 10, +0.15, ID9.70</p>

Accessories Line-up – Valve box for 3 pipe Heat Recovery outdoor unit

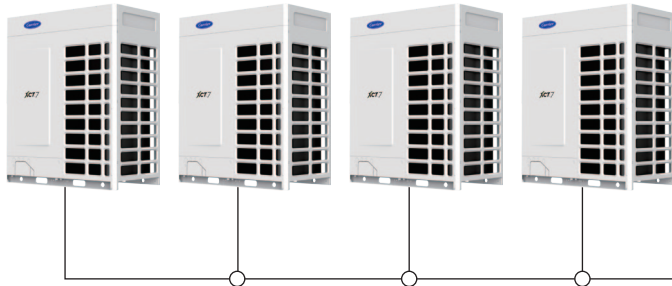

Different scenario for Refrigerant piping connection according valve box connection rules :

1. Multi 4port valve box installed in a line
2. less than 4 IDUs connected to 4port VB
3. More than 4 IDU on a 4port Valve box
4. More IDU connected to a 1port Valve box
5. IDU connected without Valve box

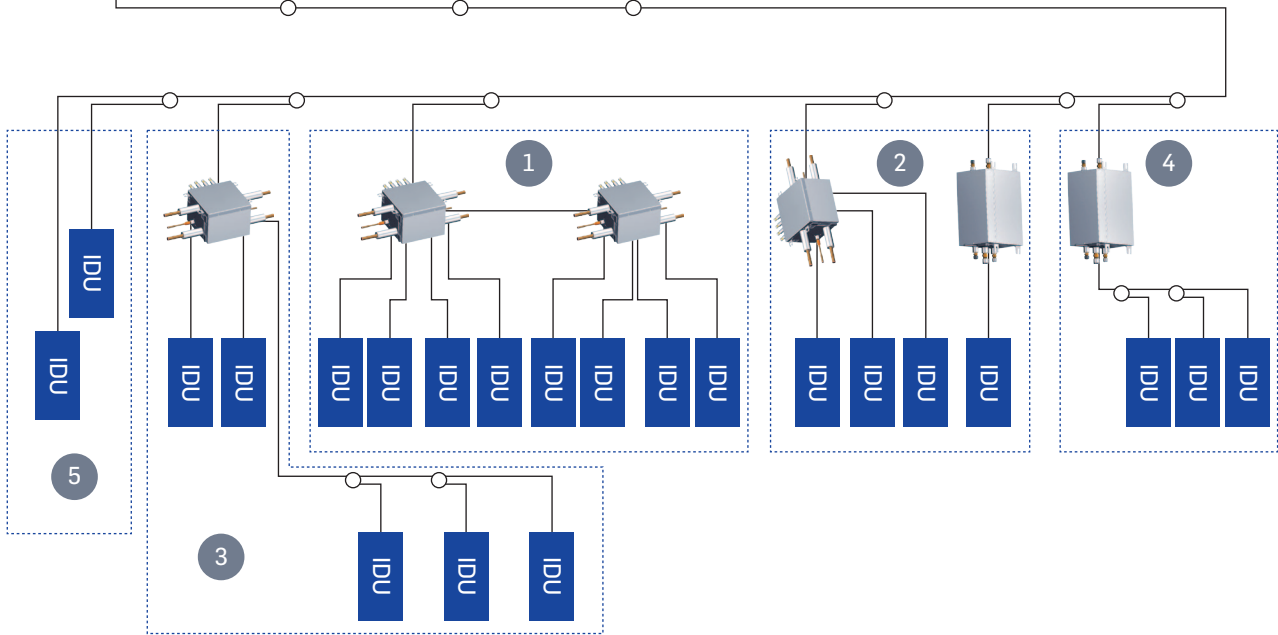

EXV Type	Model Code	40VX	00417FRQEE	00717FRQEE	01017FRQEE	01647FRQEE
<div style="display: flex; flex-direction: column; align-items: center;"> <div style="margin-bottom: 10px;">1 Port </div> <div>4 Ports </div> </div>	Power Supply	Ph/V/Hz	1/220~240/50/60			
	Number of Ports		1			4
	Maximum Indoor Units		5	8	8	20
	Max IDU Capacity	kW	≤ 11.2	11.2 < ≤ 18	18 < ≤ 28	≤ 45
	External Dimension (LxWxH)	mm	388 x 200 x 276			405 x 300 x 421
	Net Weight	kg	8.6			9.3

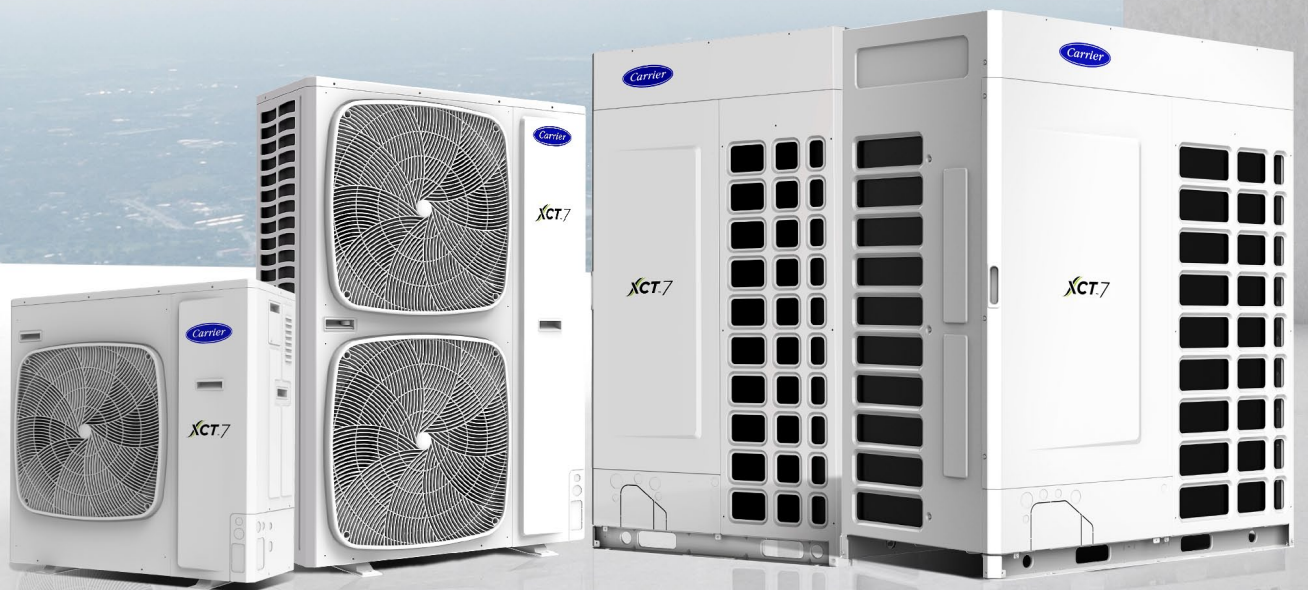





Turn to the experts

Type	Product Family Name	Carrier Model Code	Page
<b>Outdoor Units</b>	Side Discharge Heat Pump Dual Fan 4-5-6 HP	38VS*17S/3H	37
	Side Discharge Heat Pump Dual Fan 8-10-12 HP	38VS*174H	39
	Side Discharge Heat Pump Single Fan 4-5 HP	38VS*C7SH	40
	Top Discharge Heat Pump	38VT*173H	49
	Top Discharge Heat Recovery	38VT*173R	55
<b>Indoor Units</b>	One-Way Cassette	40VU*1-7E	67
	Two-Way Cassette	40VU*2-7G	71
	Compact Four-Way Cassette	40VU*C-7S	75
	Round-Way Cassette	40VU*R-7E	79
	Slim Duct	40VD*L-7E	85
	Standard Static Duct 20-200 Pa	40VD*S-7S	89
	High Static Duct 0-200 Pa	40VD*H-7S	93
	High Wall	40VK*S-7S	99
	Two-Way Console	40VL*B-7E	103
	Console Recessed	40VL*R-7G	107
	Flex Ceiling Floor (AC Fan)	40VC*F-7G	109
	Flex Ceiling Floor (DC Fan)	40VC*F-7S	111
Heat Reclaim Ventilation	40VH*A-7G	117	
<b>Controls</b>		40VC	130
<b>Accessories</b>		40VJ	154
		40VX	163

## ICON LIST

- |   |  |                                   |  |
|---|--|-----------------------------------|--|
| High reliability                                  | Easy installation & access & fix & maintenance   | Advanced technology               | AHU DX coil kit (TA Control)                                 |
| Enhanced performance                              | One button trial operation                       | Brazing refrigerant               | Unit structure   |
| High efficiency                                   | Powerful heating                                 | Advanced separator                | Individual controller  |
| Compact design & ultra-thin design & space saving | Knockout hole for outside fresh air              | Fan motor.                        | Centralized controller                                       |
| Wide range of capacity                            | Large operating range                            | Built-in drain pump               | BMS - Local control  |
| Wide range of options                             | Bottom or rear air return                        | Administrations                   | BMS gateways   |
| Superior comfort                                  | Independent or flexible control of the air flow  | Offices                           | Control systems  |
| Low sound level                                   | Static pressure setting                          | Hotels                            | Can be installed with or without discharge & return plenum   |
| Effective control of the temperature              | Light air resistance                             | Retail                            | Hidden installation for a clean and sophisticated appearance |
| Independent 220v power                            | PM 2.5 filter available                          | Healthcare                        | Flexible discharge duct connection                           |
| Automatic display of fault codes                  | Advanced black-coated fin technology             | Individual and collective housing | Multiple direction for connection pipe setting               |
| Unique design                                     | Reliable multi-layer oil return technology       | Pipe liner                        | Cooling  |
| Round corner design                               | Advanced compressor anti-liquid-shock technology | Rear & bottom inlet               | Heating  |

## GREECE

AHI CARRIER S.E. EUROPE SINGLE MEMBER S.A.

Headquarters  
18, Kifissou Ave.  
104 42 - Athens  
Tel.: +30 210 6796300

Thessaloniki Branch  
5, Ag. Georgioly str., Cosmos Offices  
570 01 - Patriarhiko Pileas Thessaloniki  
Tel.: +30 231 3080430

grinfo@ahi-carrier.eu  
www.ahi-carrier.gr  
www.toshiba-aircon.gr

## BULGARIA

AHI CARRIER HVAC BULGARIA EOOD  
Trade Center Europe Building 6,  
floor 3, office 6  
7 Iskarsko Shose Blvd., Sofia 1528  
Tel.: +35 929483960  
bginfo@ahi-carrier.com  
www.ahi-carrier.bg  
www.toshiba-aircon.bg

## ROMANIA

AHI CARRIER ROMANIA SRL  
Intrarea Nestorei 1, Corp B, Et. 5, Sector 4  
Cladirea River Plaza, RO-040295 Bucuresti  
Tel.: +40 214 050751  
roinfo@ahi-carrier.eu  
www.ahi-carrier.ro  
www.toshiba-aircon.ro

## AUSTRIA

AHI CARRIER GMBH  
Andromeda Tower, Donau-City Str. 6/9  
1220 Wien, Österreich  
Tel.: +43 1 269 969 710  
info@ahi-carrier.at  
www.ahi-carrier.at

## CZECH REPUBLIC

AHI CARRIER CZ S.R.O.  
Styblova 253/13,  
14900 Praha 5, Chodov  
Tel.: +420 212 812 030  
info@ahi-carrier.cz  
www.ahi-carrier.cz

**Your VRF System of Choice**

[www.carrier.com](http://www.carrier.com)

Carrier is committed to continuously improving its products to ensure the highest quality and reliability standards, and to meet local regulations and market requirements. All features and specifications are subject to change without prior notice. All Trademarks referenced on this material are the Trademark of their respective owners.